

# TOSHIBA

## SERVICE MANUAL

# AIR-CONDITIONER

## SPLIT TYPE

**Indoor Unit**

**<Console, Heat Pump Type>**

***RAS-10J2FVG-TR***

***RAS-13J2FVG-TR***

***RAS-18J2FVG-TR***

***RAS-10J2AVSG-TR***

***RAS-13J2AVSG-TR***

***RAS-18J2AVSG-TR***

***RAS-10J2AVSG-TR1***

***RAS-13J2AVSG-TR1***

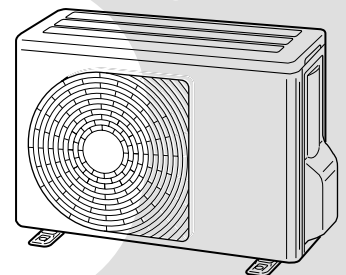
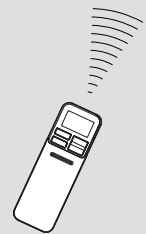
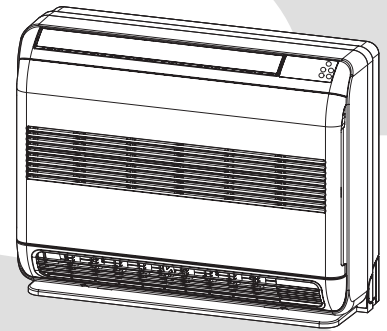

**R32 or R410A**

***INVERTER***



*Revised on June, 2021*

# CONTENTS



1. SAFETY PRECAUTIONS .....	3
2. SPECIFICATIONS .....	7
3. REFRIGERANT R32 .....	9
4. CONSTRUCTION VIEWS .....	17
5. WIRING DIAGRAM .....	19
6. SPECIFICATIONS OF ELECTRICAL PARTS .....	21
7. REFRIGERANT CYCLE DIAGRAM .....	22
8. CONTROL BLOCK DIAGRAM .....	26
9. OPERATION DESCRIPTION .....	29
10. INSTALLATION PROCEDURE .....	69
11. HOW TO DIAGNOSE THE TROUBLE .....	82
12. HOW TO REPLACE THE MAIN PARTS .....	106
13. EXPLODED VIEWS AND PARTS LIST .....	127

# 1. SAFETY PRECAUTIONS

## SAFETY PRECAUTIONS



The important contents concerned to the safety are described on the product itself and on this Service Manual. Please read this Service Manual after understanding the described items thoroughly in the following contents (Indications/Illustrated marks), and keep them.





### [Explanation of indications]

Indication	Explanation
 <b>DANGER</b>	Indicates contents assumed that an imminent danger causing a death or serious injury of the repair engineers and the third parties when an incorrect work has been executed.
 <b>WARNING</b>	Indicates possibilities assumed that a danger causing a death or serious injury of the repair engineers, the third parties, and the users due to troubles of the product after work when an incorrect work has been executed.
 <b>CAUTION</b>	Indicates contents assumed that an injury or property damage (*) may be caused on the repair engineers, the third parties, and the users due to troubles of the product after work when an incorrect work has been executed.

\* Property damage : Enlarged damage concerned to property, furniture, and domestic animal/pet

### [Explanation of illustrated marks]

Mark	Explanation
	Indicates prohibited items (Forbidden items to do) The sentences near an illustrated mark describe the concrete prohibited contents.
	Indicates mandatory items (Compulsory items to do) The sentences near an illustrated mark describe the concrete mandatory contents.
	Indicates cautions (including danger/warning) The sentences or illustration near or in an illustrated mark describe the concrete cautious contents.

	Read the precautions in this manual carefully before operating the unit.		This appliance is filled with R32. (Flammable Material)
	Information included in the Operation Manual and/or Installation Manual.		Service personnel should be handling this equipment with reference to the Installation Manual.

### Warning Indications on the Air Conditioner Unit

Warning indication	Description
 <b>DİKKAT</b> <b>PATLAMA TEHLİKESİ</b> Çalıştırmadan önce servis valflerini açın, aksi takdirde patlama olabilir.	<b>CAUTION</b> <b>BURST HAZARD</b> Open the service valves before the operation, otherwise there might be the burst.

#### For general public use

Power supply cord of outdoor unit shall be more than 1.5 mm<sup>2</sup> (H07RN-F or 60245IEC66) polychloroprene sheathed flexible cord.

- Read this "SAFETY PRECAUTIONS" carefully before servicing.
- The precautions described below include the important items regarding safety. Observe them without fail.
- After the servicing work, perform a trial operation to check for any problem.
- Turn off the main power supply switch (or breaker) before the unit maintenance.

#### ■ Important information regarding the refrigerant used

This product contains fluorinated greenhouse gases.

Do not vent gases into the atmosphere. Refrigerant type: **R32**

GWP<sup>(1)</sup> value: **675\*** (ex. R32 ref. AR4)

<sup>(1)</sup>GWP = global warming potential

The refrigerant quantity is indicated on the unit name plate.

\* This value is based on F gas regulation 517/2014

#### ADOPTION OF R32 or R410A REFRIGERANT

This Air Conditioner has adopted a refrigerant HFC (R32 or R410A) which does not destroy the ozone layer.

### CAUTION

#### TO DISCONNECT THE APPLIANCE FROM THE MAIN POWER SUPPLY

This appliance must be connected to the main power supply by a circuit breaker or a switch with a contact separation of at least 3 mm.

## DANGER

- **ASK AN AUTHORIZED DEALER OR QUALIFIED INSTALLATION PROFESSIONAL TO INSTALL/MAINTAIN THE AIR CONDITIONER.**

INAPPROPRIATE SERVICING MAY RESULT IN WATER LEAKAGE, ELECTRIC SHOCK OR FIRE.

- **TURN OFF MAIN POWER SUPPLY BEFORE ATTEMPTING ANY ELECTRICAL WORK. MAKE SURE ALL POWER SWITCHES ARE OFF. FAILURE TO DO SO MAY CAUSE ELECTRIC SHOCK.**



### **DANGER: HIGH VOLTAGE**

The high voltage circuit is incorporated.

Be careful to do the check service, as the electric shock may be caused in case of touching parts on the P.C. board by hand.

- **CORRECTLY CONNECT THE CONNECTING CABLE. IF THE CONNECTING CABLE IS INCORRECTLY CONNECTED, ELECTRIC PARTS MAY BE DAMAGED.**
- **CHECK THAT THE EARTH WIRE IS NOT BROKEN OR DISCONNECTED BEFORE SERVICE AND INSTALLATION. FAILURE TO DO SO MAY CAUSE ELECTRIC SHOCK.**
- **DO NOT INSTALL NEAR CONCENTRATIONS OF COMBUSTIBLE GAS OR GAS VAPORS. FAILURE TO FOLLOW THIS INSTRUCTION CAN RESULT IN FIRE OR EXPLOSION.**
- **TO PREVENT THE INDOOR UNIT FROM OVERHEATING AND CAUSING A FIRE HAZARD, PLACE THE UNIT WELL AWAY (MORE THAN 2 M) FROM HEAT SOURCES SUCH AS RADIATORS, HEAT REGISTORS, FURNACE, STOVES, ETC.**
- **WHEN MOVING THE AIR-CONDITIONER FOR INSTALLATION IN ANOTHER PLACE, BE VERY CAREFUL NOT TO ALLOW THE SPECIFIED REFRIGERANT (R410A) TO BECOME MIXED WITH ANY OTHER GASEOUS BODY INTO THE REFRIGERATION CIRCUIT. IF AIR OR ANY OTHER GAS IS MIXED IN THE REFRIGERANT, THE GAS PRESSURE IN THE REFRIGERATION CIRCUIT WILL BECOME ABNORMALLY HIGH AND IT MAY RESULT IN THE PIPE BURSTING AND POSSIBLE PERSONNEL INJURIES.**
- **IN THE EVENT THAT THE REFRIGERANT GAS LEAKS OUT OF THE PIPE DURING THE SERVICE WORK AND THE INSTALLATION WORK, IMMEDIATELY LET FRESH AIR INTO THE ROOM. IF THE REFRIGERANT GAS IS HEATED, SUCH AS BY FIRE, GENERATION OF POISONOUS GAS MAY RESULT.**

## WARNING

- **Never modify this unit by removing any of the safety guards or bypass any of the safety interlock switches.**
- **Do not install in a place which cannot bear the weight of the unit. Personal injury and property damage can result if the unit falls.**
- **After the installation work, confirm that refrigerant gas does not leak.**  
If refrigerant gas leaks into the room and flows near a fire source, such as a cooking range, noxious gas may generate.
- **The electrical work must be performed by a qualified electrician in accordance with the Installation Manual. Make sure the air conditioner uses an exclusive circuit.**  
An insufficient circuit capacity or inappropriate installation may cause fire.
- **When wiring, use the specified cables and connect the terminals securely to prevent external forces applied to the cable from affecting the terminals.**
- **Be sure to provide grounding.**  
Do not connect ground wires to gas pipes, water pipes, lightning rods or ground wires for telephone cables.
- **Conform to the regulations of the local electric company when wiring the power supply.**  
Inappropriate grounding may cause electric shock.
- **Manufacturer pay no responsibility to any damage, caused by heating cable, being outside of unit.**

- Do not pierce or burn as the appliance is pressurized. Do not expose the appliance to heat, flame, sparks, or other sources or ignition. Else, it may explode and cause injury or death.
- A special tool for the R32 or R410A refrigerant is required for installation.
- Thickness of copper pipes used R32 must be more than 0.8mm. Never use copper pipes thinner than 0.8mm.
- After completion of installation or service, confirm there is no leakage of refrigerant gas. It may generate toxic gas when the refrigerant contacts with fire.
- Comply with national gas regulations.

### WARNING

- **After installation work, make sure below before operation.**

- **Connection pipes are connected properly and no leakage.**

- **Packed valves are fully open.**

Running compressor without open packed valves may cause abnormal high pressure and parts failure. Leakage at connection piping may suck air and make further high pressure cause burst and injure.

- **During pump down work make sure below process.**

- **Don't mix air into the refrigerant cycle.**

- **Stop the compressor before removing piping after packed valves are fully closed.**

Removing piping under the compressor running and packed valves open, air might be sucked and refrigeration cycle pressure becomes abnormally high, and it causes burst or injury on persons.

### CAUTION

- Exposure of unit to water or other moisture before installation may result in an electrical short. Do not store in a wet basement or expose to rain or water.
- Do not install in a place that can increase the vibration of the unit. Do not install in a place that can amplify the noise level of the unit or where noise or discharged air might disturb neighbors.
- To avoid personal injury, be careful when handling parts with sharp edges.
- **Perform the specified installation work to guard against an earthquake.**  
If the air conditioner is not installed appropriately, accidents may occur due to the falling unit.
- Please read this installation manual carefully before installing the unit. It contains further important instructions for proper installation, Improper installation may cause fire, burst, electric shock, injury and water leakage.

#### For Reference:

If a heating operation would be continuously performed for a long time under the condition that the outdoor temperature is 0°C or lower, drainage of defrosted water may be difficult due to freezing of the bottom plate, resulting in a trouble of the cabinet or fan.

It is recommended to procure an antifreeze heater locally for a safe installation of the air conditioner.

For details, contact the dealer.

## 2. SPECIFICATIONS

### 2-1. Specifications

Unit model		Indoor		RAS-10J2FVG-TR	RAS-13J2FVG-TR	RAS-18J2FVG-TR				
		Outdoor		RAS-10J2AVSG-TR,TR1	RAS-13J2AVSG-TR,TR1	RAS-18J2AVSG-TR				
Cooling capacity			(kW)	2.50	3.50	5.00				
Cooling capacity range			(kW)	0.95-3.20	1.05-4.10	1.20-5.60				
Heating capacity			(kW)	3.20	4.20	6.00				
Heating capacity range			(kW)	0.85-4.40	1.00-5.00	1.30-6.30				
Power supply	1Ph/50Hz/220-240V									
Electric characteristic	Indoor	Operation mode		<b>Cooling</b>	<b>Heating</b>	<b>Cooling</b>	<b>Heating</b>	<b>Cooling</b>	<b>Heating</b>	
		Running current	(A)	0.19-0.17	0.19-0.17	0.23-0.21	0.23-0.21	0.30-0.28	0.30-0.28	
		Power consumption	(W)	25	25	30	30	40	40	
			Power factor	(%)	60	60	59	59	60	60
	Outdoor	Operation mode		<b>Cooling</b>	<b>Heating</b>	<b>Cooling</b>	<b>Heating</b>	<b>Cooling</b>	<b>Heating</b>	
		Running current	(A)	2.94-2.68	4.01-3.68	4.17-3.84	6.02-5.54	7.90-7.27	9.40-8.62	
		Power consumption	(W)	565	795	840	1240	1640	2010	
		Power factor	(%)	87	90	92	93	95	97	
			Starting current	(A)	3.13-2.85	4.20-3.85	4.40-4.05	6.25-5.75	8.20-7.55	9.70-8.90
	COP (Cooling / Heating)				4.24/3.90	4.02/3.31	2.98/2.93			
Operating noise	Indoor	High	(Cooling / Heating) (dB-A)	39/39	40/40	46/47				
		Medium	(Cooling / Heating) (dB-A)	32/32	33/33	40/40				
		Low	(Cooling / Heating) (dB-A)	28/26	27/27	34/34				
	Outdoor	(Cooling / Heating) (dB-A)	45/47	47/49	49/51					
Indoor unit	Unit model			<b>RAS-10J2FVG-TR</b>	<b>RAS-13J2FVG-TR</b>	<b>RAS-18J2FVG-TR</b>				
	Dimension	Height	(mm)	600	600	600				
		Width	(mm)	700	700	700				
		Depth	(mm)	220	220	220				
	Net weight		(kg)	16	16	16				
	Fan motor output		(W)	41	41	41				
	Air flow rate		(Cooling / Heating) (m <sup>3</sup> / min)	8.2/8.2	8.8/9.2	10.0/11.0				
Outdoor unit	Unit model			<b>RAS-10J2AVSG-TR,TR1</b>	<b>RAS-13J2AVSG-TR,TR1</b>	<b>RAS-18J2AVSG-TR</b>				
	Dimension	Height	(mm)	550	550	550				
		Width	(mm)	780	780	780				
		Depth	(mm)	290	290	290				
	Net weight		(kg)	26	30	34				
	Compressor	Motor output	(W)	620	715	1050				
		Type		Single rotary type with DC-inverter variable speed control			Twin rotary type with DC-inverter variable speed control			
		Model		KSK75D43UEZA	KSK89D53UFZ	KTN130D30UFZ				
	Fan motor output		(W)	43	43	43				
	Air flow rate		(Cooling / Heating) (m <sup>3</sup> / min)	31.5/31.5	32.5/32.5	34.6/34.6				
Piping connection	Type			Flare connection		Flare connection				
	Indoor unit	Liquid side	(mm)	Ø6.35		Ø6.35				
		Gas side	(mm)	Ø9.52		Ø12.7				
	Outdoor unit	Liquid side	(mm)	6.35		6.35				
		Gas side	(mm)	9.52		12.7				
	Maximum length		(m)	20		20				
	Maximum charge-less length		(m)	15		15				
	Maximum height difference		(m)	12		12				
Refrigerant	Name of refrigerant			R32		R32				
	Weight		(kg)	0.55	0.80	1.10				
Wiring connection	Power supply			*	*	*				
	Interconnection			4 Wires:Includes earth						
Usable temperature range	Indoor	(Cooling / Heating) (°C)	21-32/ -28							
	Outdoor	(Cooling / Heating) (°C)	-10-46/-15-24							
Accessory	Indoor unit	Installation plate		1						
		Wireless remote controller		1						
		Batteries		2						
		Toshiba New IAQ Filter		2						
		Install screw		8						
		Remote controller holder		1						
		Pan head wood screw for Remote control holder		2						
		Insulate pipe		1						
		Installation manual		1						
		Owner's manual		1						
	Outdoor unit	Drain nipple		*						
Water-proof rubber cap			*							

\* The specification may be subject to change without notice for purpose of improvement.

## 2-2. Operation Characteristic Curve

<Cooling>

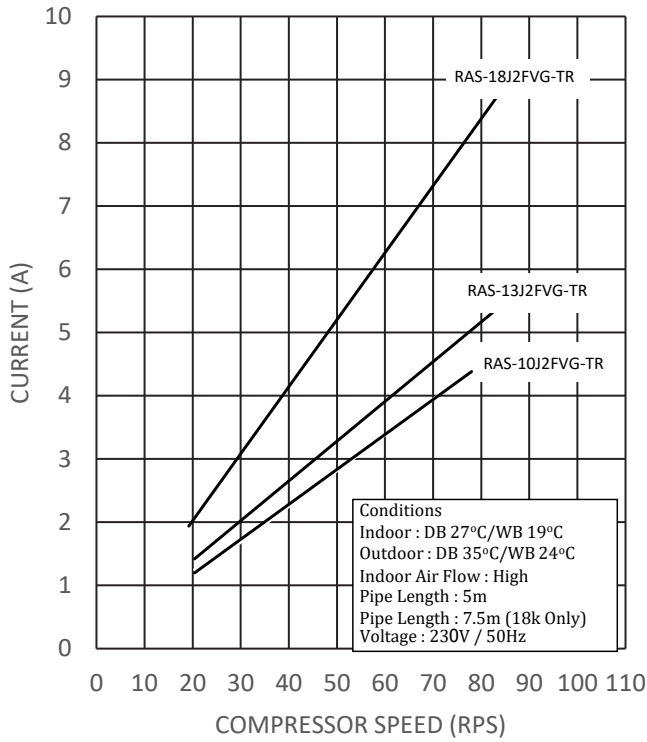

<Heating>

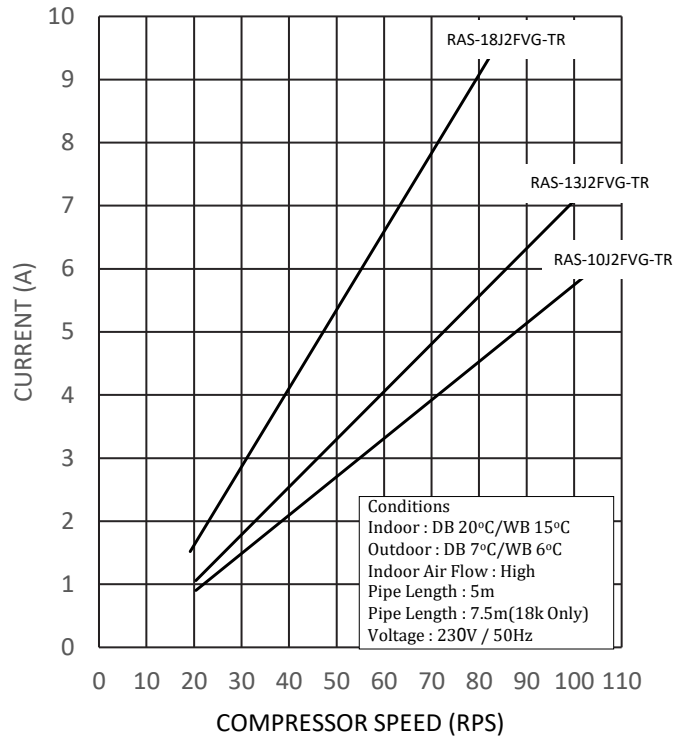

## 2-3. Capacity Variation ratio According to Temperature.

<Cooling>

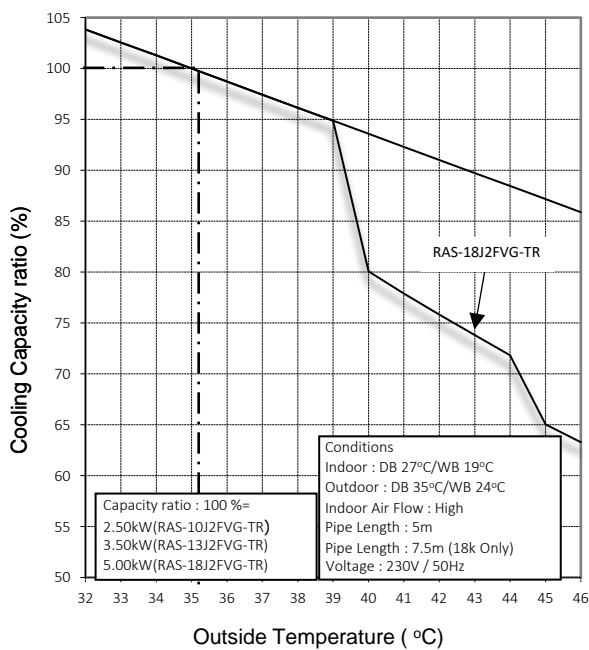

<Heating>

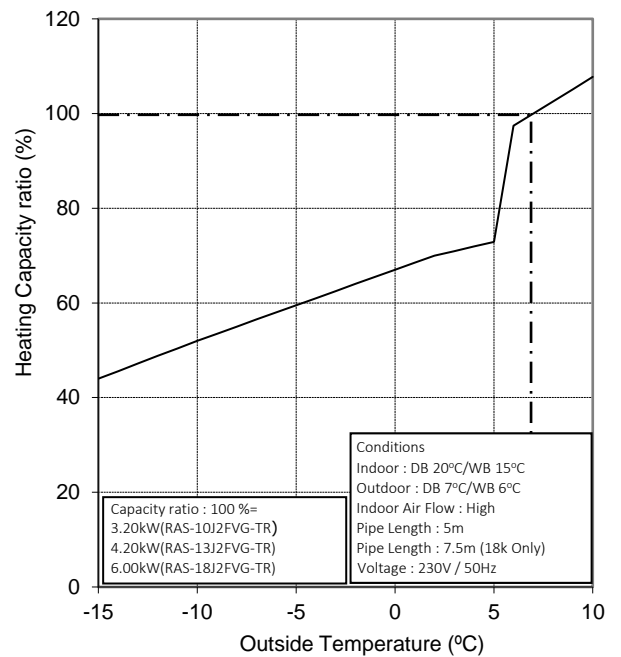



### 3. REFRIGERANT R32

This air conditioner adopts the new refrigerant HFC (R32) which does not damage the ozone layer.

The next section describes the precautions for air conditioner using the new refrigerant. Conforming to contents of the next section together with the general cautions included in this manual, perform the correct and safe work.

#### 3-1. Safety During Installation/Service

The basic installation servicing work procedures are the same as conventional R410A models.

As R32's pressure is about 1.6 times higher than that of R22, improper installation/servicing may cause a serious trouble. By using tools and materials exclusive for R32, it is necessary to carry out installation/servicing safely while taking the following precautions into consideration.

1. Never use refrigerant other than R32 in an air conditioner which is designed to operate with R32. If other refrigerant than R32 is mixed, pressure in the refrigeration cycle becomes abnormally high, and it may cause personal injury, etc. by a rupture.
2. Confirm the used refrigerant name, and use tools and materials exclusive for the refrigerant. The refrigerant name R32 is indicated on the visible place of the outdoor unit of the air conditioner using R32 as refrigerant. To prevent mischarging, the diameter of the service port differs from that of R22. R32 and other HFCs are heavier than air, and therefore they are inclined to settle near the floor surface. If the gas fills up the room or the bottom part of a room, it may also cause oxygen deficiency and may reach its combustion concentration.

**In order to prevent oxygen deficiency and R32 combustion, keep the room well-ventilated for a healthy work environment.**

In particular, using HFCs in a basement room or confined area creates a higher risk; be sure to furnish the room with local exhaust ventilation. If a refrigerant leak is confirmed in a room an inadequately ventilated location, do not use a flame until the area has been ventilated appropriately and the work environment has been improved.

**The same applies in case of brazing, ensure appropriate ventilation to prevent oxygen deficiency and R32 combustion.**

Check that there are no dangerous or combustible items nearby, and ensure a fire extinguisher is close at hand.

Keep a sufficient distance away from causes of fire (ignition sources) such as gas-burning equipment and electric heaters in places where installation, repairs, or similar work on air-conditioning equipment is performed.

3. If a refrigeration gas leakage occurs during installation/servicing, be sure to ventilate fully. If the refrigerant gas comes into contact with fire, a poisonous gas may occur.
4. When installing or removing an air conditioner, do not allow air moisture dust or oil to remain in the refrigeration cycle. Otherwise, pressure in the refrigeration cycle may become abnormally high so that a rupture or personal injury may be caused.
5. After completion of installation work, check to make sure that there is no refrigeration gas leakage. If the refrigerant gas leaks into the room, coming into contact with fire in the fan-driven heater, space heater, etc., a poisonous gas may occur
6. When an air conditioning system charged with a large volume of refrigerant is installed in a small room, it is necessary to exercise care so that, even when refrigerant leaks, its concentration does not exceed the marginal level. If the refrigerant gas leakage occurs and its concentration exceeds the marginal level, an oxygen starvation accident may result.
7. Be sure to carry out installation or removal according to the installation manual. Improper installation may cause refrigeration trouble, water leakage, electric shock, fire, etc.
8. Unauthorized modifications to the air conditioner may be dangerous. If a breakdown occurs please call a qualified air conditioner technician or electrician. Improper repair's may result in water leakage, electric shock and fire, etc.

#### 3-2. Refrigerant Piping Installation

##### 3-2-1. Piping Materials and Joints Used

For the refrigerant piping installation, copper pipes and joints are mainly used. Copper pipes and joints suitable for the refrigerant must be chosen and installed. Furthermore, it is necessary to use clean copper pipes and joints whose interior surfaces are less affected by contaminants.

##### 1. Copper Pipes

It is necessary to use seamless copper pipes which are made of either copper or copper alloy and it is desirable that the amount of residual oil is less than 40 mg/10 m. Do not use copper pipes having a collapsed, deformed or discolored portion (especially on the interior surface).

Otherwise, the expansion valve or capillary tube may become blocked with contaminants.

As an air conditioner using R32 incurs pressure higher than when using R22, it is necessary to choose adequate materials.

Thicknesses of copper pipes used with R32 are as shown in Table 3-2-1. Never use copper pipes thinner than 0.8 mm even when it is available on the market.

**Table 3-2-1 Thicknesses of annealed copper pipes**

		Thickness (mm)	
Nominal diameter	Outer diameter (mm)	R32(R410A)	R22
1/4	6.35	0.80	0.80
3/8	9.52	0.80	0.80
1/2	12.70	0.80	0.80
5/8	15.88	1.00	1.00

**2. Joints**

For copper pipes, flare joints or socket joints are used. Prior to use, be sure to remove all contaminants.

**a) Flare Joints**

Flare joints used to connect the copper pipes cannot be used for pipings whose outer diameter exceeds 20 mm. In such a case, socket joints can be used.

Sizes of flare pipe ends, flare joint ends and flare nuts are as shown in Tables 3-2-3 to 3-2-6 below.

**b) Socket Joints**

Socket joints are such that they are brazed for connections, and used mainly for thick pipings whose diameter is larger than 20 mm.

Thicknesses of socket joints are as shown in Table 3-2-2.

**Table 3-2-2 Minimum thicknesses of socket joints**

Nominal diameter	Reference outer diameter of copper pipe jointed (mm)	Minimum joint thickness (mm)
1/4	6.35	0.50
3/8	9.52	0.60
1/2	12.70	0.70
5/8	15.88	0.80

**3-2-2. Processing of Piping Materials**

When performing the refrigerant piping installation, care should be taken to ensure that water or dust does not enter the pipe interior, that no other oil than lubricating oils used in the installed air-water heat pump is used, and that refrigerant does not leak. When using lubricating oils in the piping processing, use such lubricating oils whose water content has been removed. When stored, be sure to seal the container with an airtight cap or any other cover.

**1. Flare processing procedures and precautions****a) Cutting the Pipe**

By means of a pipe cutter, slowly cut the pipe so that it is not deformed.

**b) Removing Burrs and Chips**

If the flared section has chips or burrs, refrigerant leakage may occur.

Carefully remove all burrs and clean the cut surface before installation.

**c) Insertion of Flare Nut**

d) Flare Processing

Make certain that a clamp bar and copper pipe have been cleaned.

By means of the clamp bar, perform the flare processing correctly.

Use either a flare tool for R32 or conventional flare tool.

Flare processing dimensions differ according to the type of flare tool. When using a conventional flare tool, be sure to secure "dimension A" by using a gauge for size adjustment.

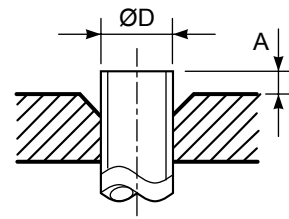

Fig. 3-2-1 Flare processing dimensions

Table 3-2-3 Dimensions related to flare processing for R32(R410A)

Nominal diameter	Outer diameter (mm)	Thickness (mm)	A (mm)		
			Flare tool for R32 clutch type	Conventional flare tool	
				Clutch type	Wing nut type
1/4	6.35	0.8	0 to 0.5	1.0 to 1.5	1.5 to 2.0
3/8	9.52	0.8	0 to 0.5	1.0 to 1.5	1.5 to 2.0
1/2	12.70	0.8	0 to 0.5	1.0 to 1.5	2.0 to 2.5
5/8	15.88	1.0	0 to 0.5	1.0 to 1.5	2.0 to 2.5

Table 3-2-4 Dimensions related to flare processing for R22

Nominal diameter	Outer diameter (mm)	Thickness (mm)	A (mm)		
			Flare tool for R22 clutch type	Conventional flare tool	
				Clutch type	Wing nut type
1/4	6.35	0.8	0 to 0.5	0.5 to 1.0	1.0 to 1.5
3/8	9.52	0.8	0 to 0.5	0.5 to 1.0	1.0 to 1.5
1/2	12.70	0.8	0 to 0.5	0.5 to 1.0	1.5 to 2.0
5/8	15.88	1.0	0 to 0.5	0.5 to 1.0	1.5 to 2.0

Table 3-2-5 Flare and flare nut dimensions for R32(R410A)

Nominal diameter	Outer diameter (mm)	Thickness (mm)	Dimension (mm)				Flare nut width (mm)
			A	B	C	D	
1/4	6.35	0.8	9.1	9.2	6.5	13	17
3/8	9.52	0.8	13.2	13.5	9.7	20	22
1/2	12.70	0.8	16.6	16.0	12.9	23	26
5/8	15.88	1.0	19.7	19.0	16.0	25	29

**Table 3-2-6 Flare and flare nut dimensions for R22**

Nominal diameter	Outer diameter (mm)	Thickness (mm)	Dimension (mm)				Flare nut width (mm)
			A	B	C	D	
1/4	6.35	0.8	9.0	9.2	6.5	13	17
3/8	9.52	0.8	13.0	13.5	9.7	20	22
1/2	12.70	0.8	16.2	16.0	12.9	20	24
5/8	15.88	1.0	19.7	19.0	16.0	23	27
3/4	19.05	1.0	23.3	24.0	19.2	34	36

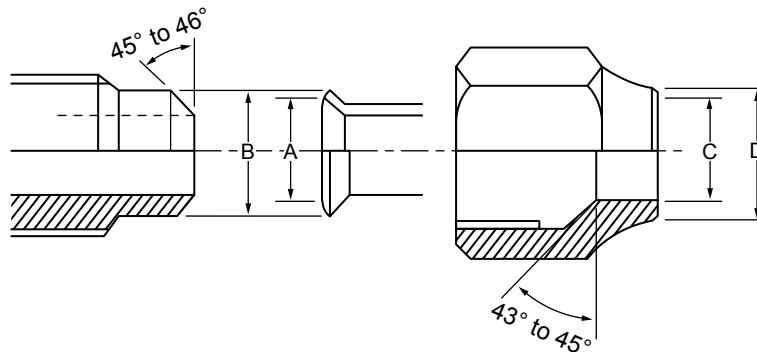

**Fig. 3-2-2 Relations between flare nut and flare seal surface**

**2. Flare Connecting Procedures and Precautions**

- a) Make sure that the flare and union portions do not have any scar or dust, etc.
- b) Correctly align the processed flare surface with the union axis.
- c) Tighten the flare with designated torque by means of a torque wrench. The tightening torque for R32 is the same as that for conventional R22. Incidentally, when the torque is weak, the gas leakage may occur. When it is strong, the flare nut may crack and may be made non-removable. When choosing the tightening torque, comply with values designated by manufacturers. Table 3-2-7 shows reference values.

**NOTE :**

When applying oil to the flare surface, be sure to use oil designated by the manufacturer. If any other oil is used, the lubricating oils may deteriorate and cause the compressor to burn out.

**Table 3-2-7 Tightening torque of flare for R32(R410A) [Reference values]**

Nominal diameter	Outer diameter (mm)	Tightening torque N•m (kgf•cm)	Tightening torque of torque wrenches available on the market N•m (kgf•cm)
1/4	6.35	14 to 18 (140 to 180)	16 (160), 18 (180)
3/8	9.52	33 to 42 (330 to 420)	42 (420)
1/2	12.70	50 to 62 (500 to 620)	55 (550)
5/8	15.88	63 to 77 (630 to 770)	65 (650)

### 3-3. Tools

#### 3-3-1. Required Tools

The service port diameter of packed valve of the outdoor unit in the air-water heat pump using R32 is changed to prevent mixing of other refrigerant. To reinforce the pressure-resisting strength, flare processing dimensions and opposite side dimension of flare nut (For Ø12.7 copper pipe) of the refrigerant piping are lengthened.

The used refrigerating oil is changed, and mixing of oil may cause a trouble such as generation of sludge, clogging of capillary, etc. Accordingly, the tools to be used are classified into the following three types.

1. Tools exclusive for R32 (Those which cannot be used for conventional refrigerant (R22))
2. Tools exclusive for R32, but can be also used for conventional refrigerant (R22)
3. Tools commonly used for R32 and for conventional refrigerant (R22)

The table below shows the tools exclusive for R32 and their interchangeability.

#### Tools exclusive for R32 (The following tools for R410A are required.)

Tools whose specifications are changed for R32 and their interchangeability

No.	Used tool	Usage	R32(R410A) air-water heat pump installation		Conventional air-water heat pump installation
			Existence of new equipment for R32	Whether conven- tional equipment can be used	Whether new equipment can be used with conventional refrigerant
1	Flare tool	Pipe flaring	Yes	*(Note 1)	○
2	Copper pipe gauge for adjusting projection margin	Flaring by conventional flare tool	Yes	*(Note 1)	*(Note 1)
3	Torque wrench (For Ø12.7)	Connection of flare nut	Yes	✕	✕
4	Gauge manifold	Evacuating, refrigerant charge, run check, etc.	Yes	✕	✕
5	Charge hose				
6	Vacuum pump adapter	Vacuum evacuating	Yes	✕	○
7	Electronic balance for refrigerant charging	Refrigerant charge	Yes	✕	○
8	Leakage detector	Gas leakage check	Yes	✕	○

**(Note 1)** When flaring is carried out for R32(R410A) using the conventional flare tools, adjustment of projection margin is necessary. For this adjustment, a copper pipe gauge, etc. are necessary.

#### General tools (Conventional tools can be used.)

In addition to the above exclusive tools, the following equipments which serve also for R22 are necessary as the general tools.

- |  |                             |   |
|--|-----------------------------|---|
| 1. Vacuum pump<br>Use vacuum pump by attaching<br>vacuum pump adapter. | 4. Reamer                   | 9. Hole core drill (Ø65)                  |
| 2. Torque wrench (For Ø6.35, Ø9.52)                                    | 5. Pipe bender              | 10. Hexagon wrench<br>(Opposite side 4mm) |
| 3. Pipe cutter   | 6. Level vial               | 11. Tape measure                          |
|  | 7. Screwdriver (+, -)       | 12. Metal saw                             |
|  | 8. Spanner or Monkey wrench |   |

Also prepare the following equipments for other installation method and run check.

- |                |                                 |
|----------------|---------------------------------|
| 1. Clamp meter | 3. Insulation resistance tester |
| 2. Thermometer | 4. Electroscop                  |

### 3-4. Recharging of Refrigerant

When it is necessary to recharge refrigerant, charge the specified amount of new refrigerant according to the following steps.

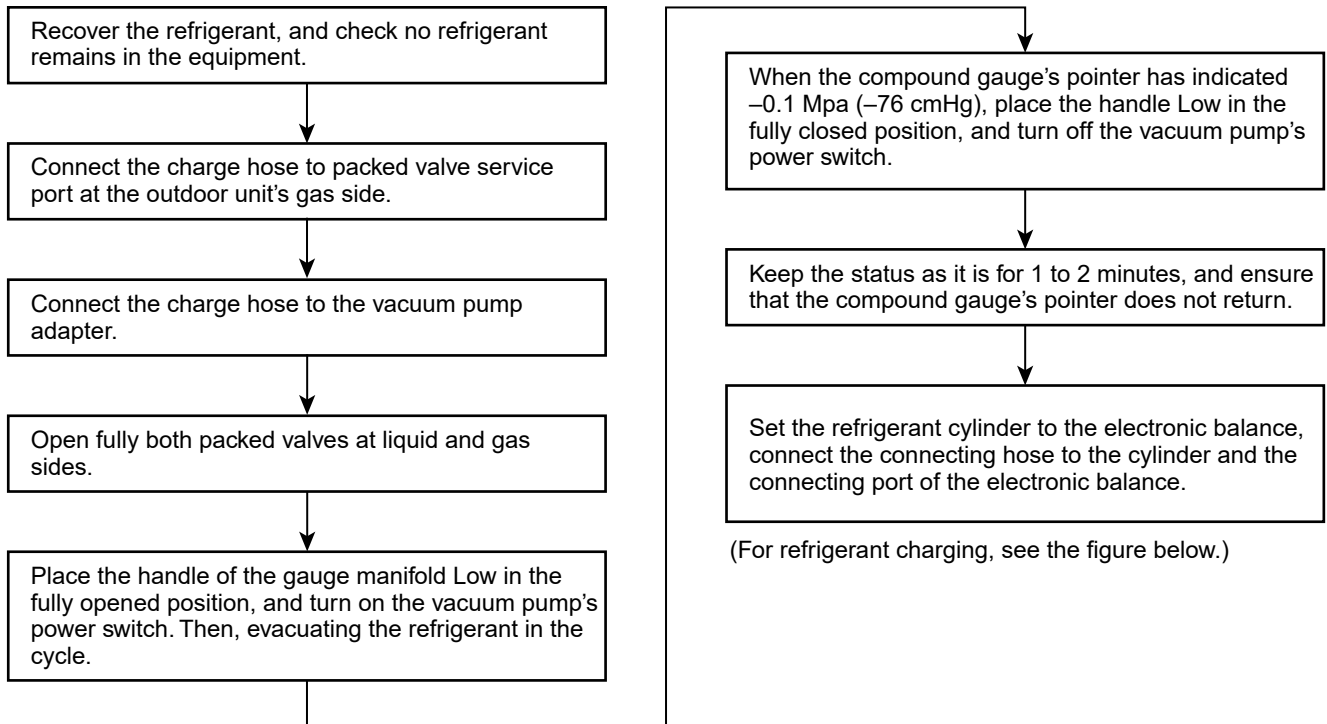

1. Never charge refrigerant exceeding the specified amount.
2. If the specified amount of refrigerant cannot be charged, charge refrigerant **bit by bit** in COOL mode.
3. Do not carry out additional charging.

When additional charging is carried out if refrigerant leaks, the refrigerant composition changes in the refrigeration cycle, that is characteristics of the air conditioner changes, refrigerant exceeding the specified amount is charged, and working pressure in the refrigeration cycle becomes abnormally high pressure, and may cause a rupture or personal injury.

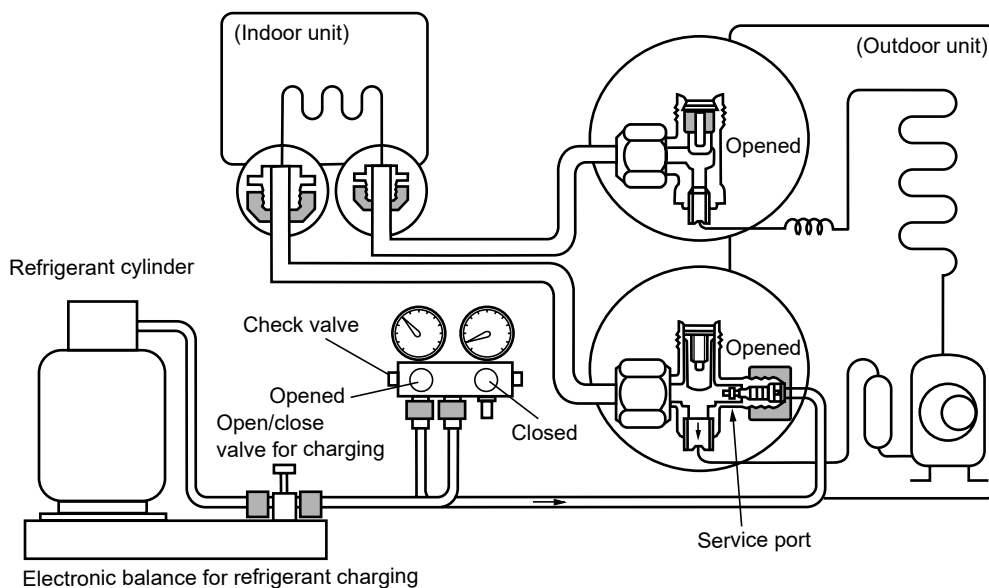

Fig. 3-4-1 Configuration of refrigerant charging

### 3-5. Brazing of Pipes

#### 3-5-1. Materials for Brazing

##### 1. Silver brazing filler

Silver brazing filler is an alloy mainly composed of silver and copper. It is used to join iron, copper or copper alloy, and is relatively expensive though it excels in solderability.

##### 2. Phosphor bronze brazing filler

Phosphor bronze brazing filler is generally used to join copper or copper alloy.

##### 3. Low temperature brazing filler

Low temperature brazing filler is generally called solder, and is an alloy of tin and lead. Since it is weak in adhesive strength, do not use it for refrigerant pipes.

1. Phosphor bronze brazing filler tends to react with sulfur and produce a fragile compound water solution, which may cause a gas leakage. Therefore, use any other type of brazing filler at a hot spring resort, etc., and coat the surface with a paint.
2. When performing brazing again at time of servicing, use the same type of brazing filler.

#### 3-5-2. Flux

##### 1. Reason why flux is necessary

- By removing the oxide film and any foreign matter on the metal surface, it assists the flow of brazing filler.
- In the brazing process, it prevents the metal surface from being oxidized.
- By reducing the brazing filler's surface tension, the brazing filler adheres better to the treated metal.

##### 2. Characteristics required for flux

- Activated temperature of flux coincides with the brazing temperature.
- Due to a wide effective temperature range, flux is hard to carbonize.
- It is easy to remove slag after brazing.
- The corrosive action to the treated metal and brazing filler is minimum.
- It excels in coating performance and is harmless to the human body.

As the flux works in a complicated manner as described above, it is necessary to select an adequate type of flux according to the type and shape of treated metal, type of brazing filler and brazing method, etc.

#### 3. Types of flux

##### • Noncorrosive flux

Generally, it is a compound of borax and boric acid.

It is effective in case where the brazing temperature is higher than 800°C.

##### • Activated flux

Most of fluxes generally used for silver brazing are this type.

It features an increased oxide film removing capability due to the addition of compounds such as potassium fluoride, potassium chloride and sodium fluoride to the borax-boric acid compound.

#### 4. Piping materials for brazing and used brazing filler/flux

Piping material	Used brazing filler	Used flux
Copper - Copper	Phosphor copper	Do not use
Copper - Iron	Silver	Paste flux
Iron - Iron	Silver	Vapor flux

1. Do not enter flux into the refrigeration cycle.
2. When chlorine contained in the flux remains within the pipe, the lubricating oil deteriorates. Therefore, use a flux which does not contain chlorine.
3. When adding water to the flux, use water which does not contain chlorine (e.g. distilled water or ion-exchange water).
4. Remove the flux after brazing.

### 3-5-3. Brazing

As brazing work requires sophisticated techniques, experiences based upon a theoretical knowledge, it must be performed by a person qualified.

In order to prevent the oxide film from occurring in the pipe interior during brazing, it is effective to proceed with brazing while letting dry Nitrogen gas (N<sub>2</sub>) flow.

**Never use gas other than Nitrogen gas.**

#### 1. Brazing method to prevent oxidation

- 1) Attach a reducing valve and a flow-meter to the Nitrogen gas cylinder.
- 2) Use a copper pipe to direct the piping material, and attach a flow-meter to the cylinder.
- 3) Apply a seal onto the clearance between the piping material and inserted copper pipe for Nitrogen in order to prevent backflow of the Nitrogen gas.
- 4) When the Nitrogen gas is flowing, be sure to keep the piping end open.
- 5) Adjust the flow rate of Nitrogen gas so that it is lower than 0.05 m<sup>3</sup>/Hr or 0.02 MPa (0.2kgf/cm<sup>2</sup>) by means of the reducing valve.
- 6) After performing the steps above, keep the Nitrogen gas flowing until the pipe cools down to a certain extent (temperature at which pipes are touchable with hands).
- 7) Remove the flux completely after brazing.

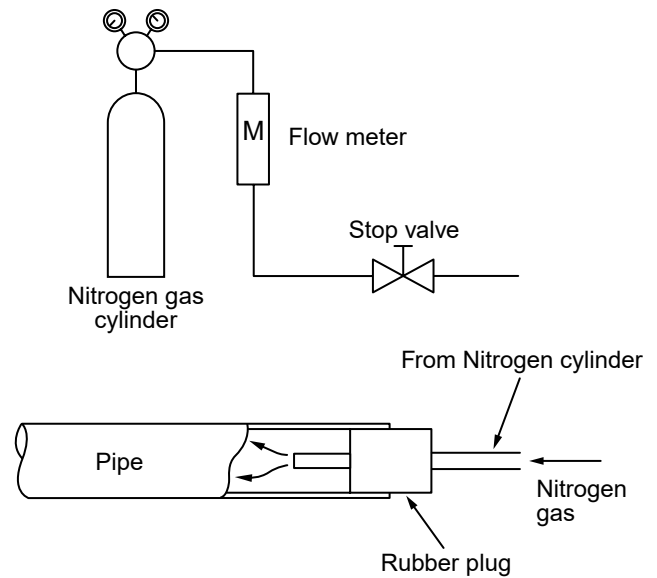
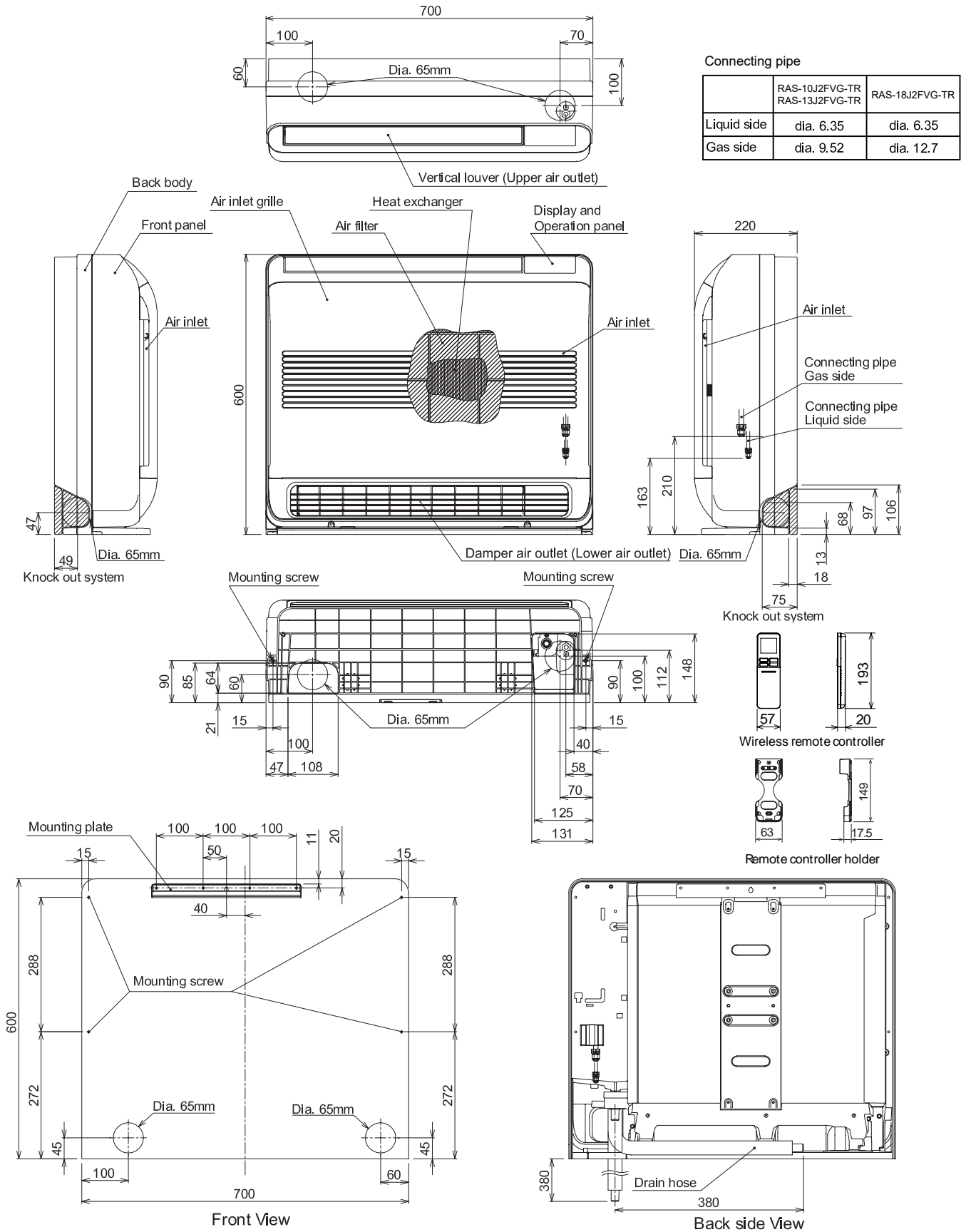

**Fig. 3-5-1 Prevention of oxidation during brazing**



# 4. CONSTRUCTION VIEWS

## 4-1. Indoor Unit



## 4-2. Outdoor Unit

(Unit : mm)

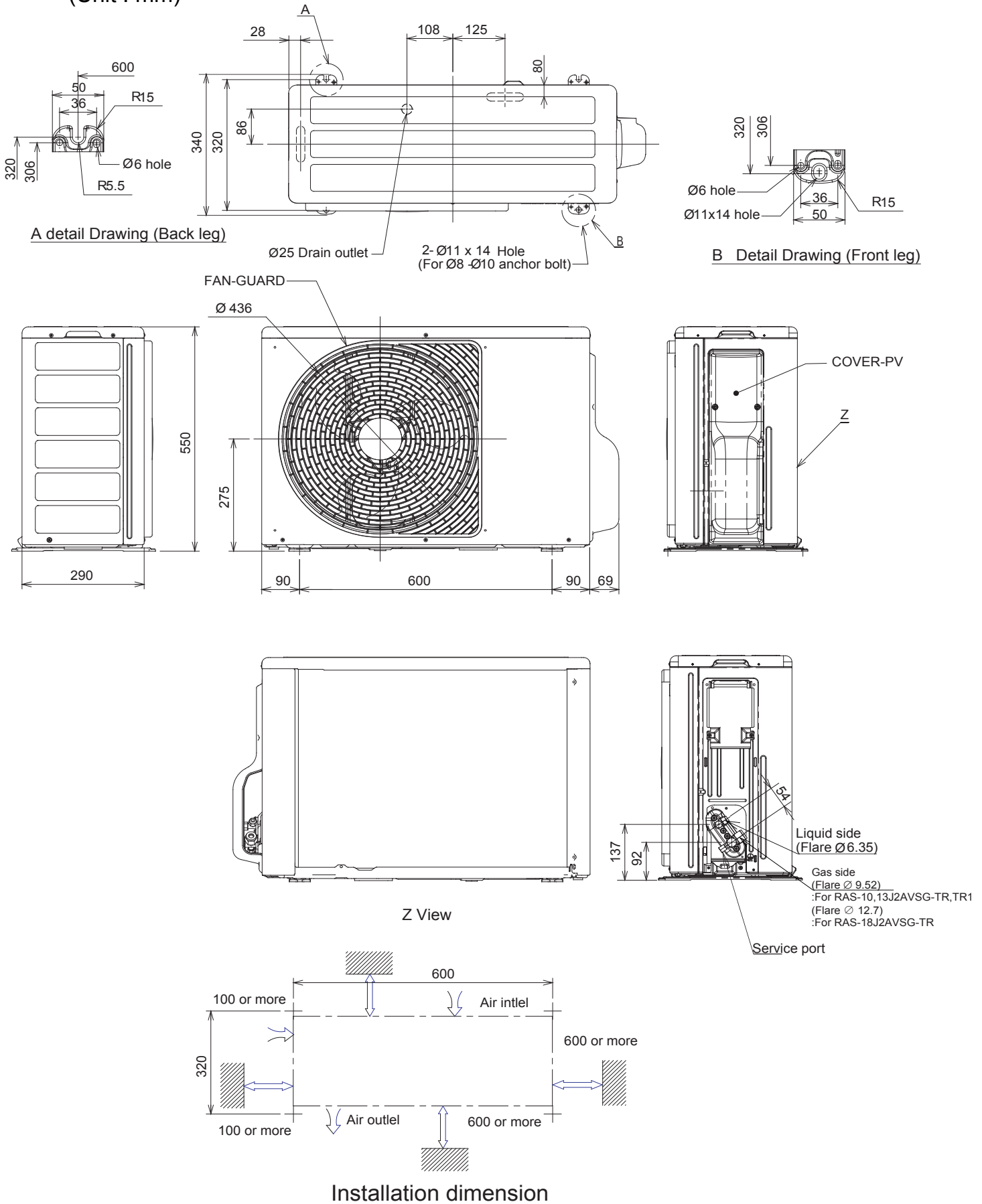

# 5. WIRING DIAGRAM

RAS-10J2FVG-TR / RAS-10J2AVSG-TR, TR1  
 RAS-13J2FVG-TR / RAS-13J2AVSG-TR, TR1

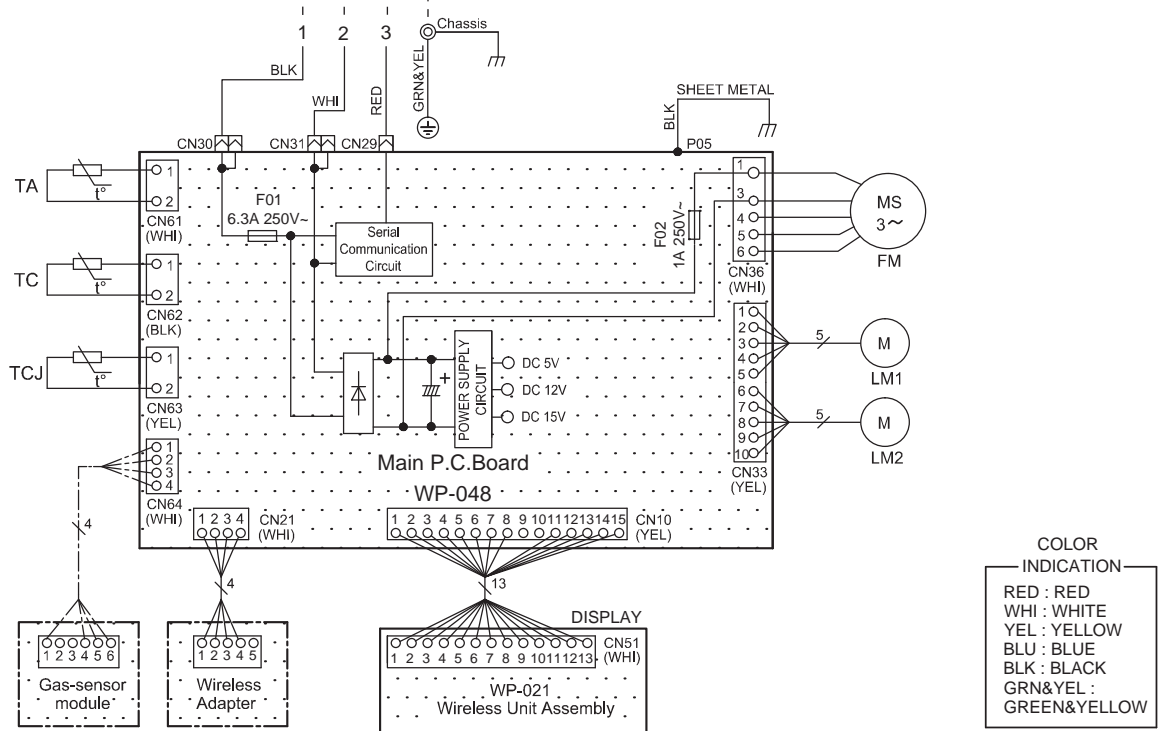
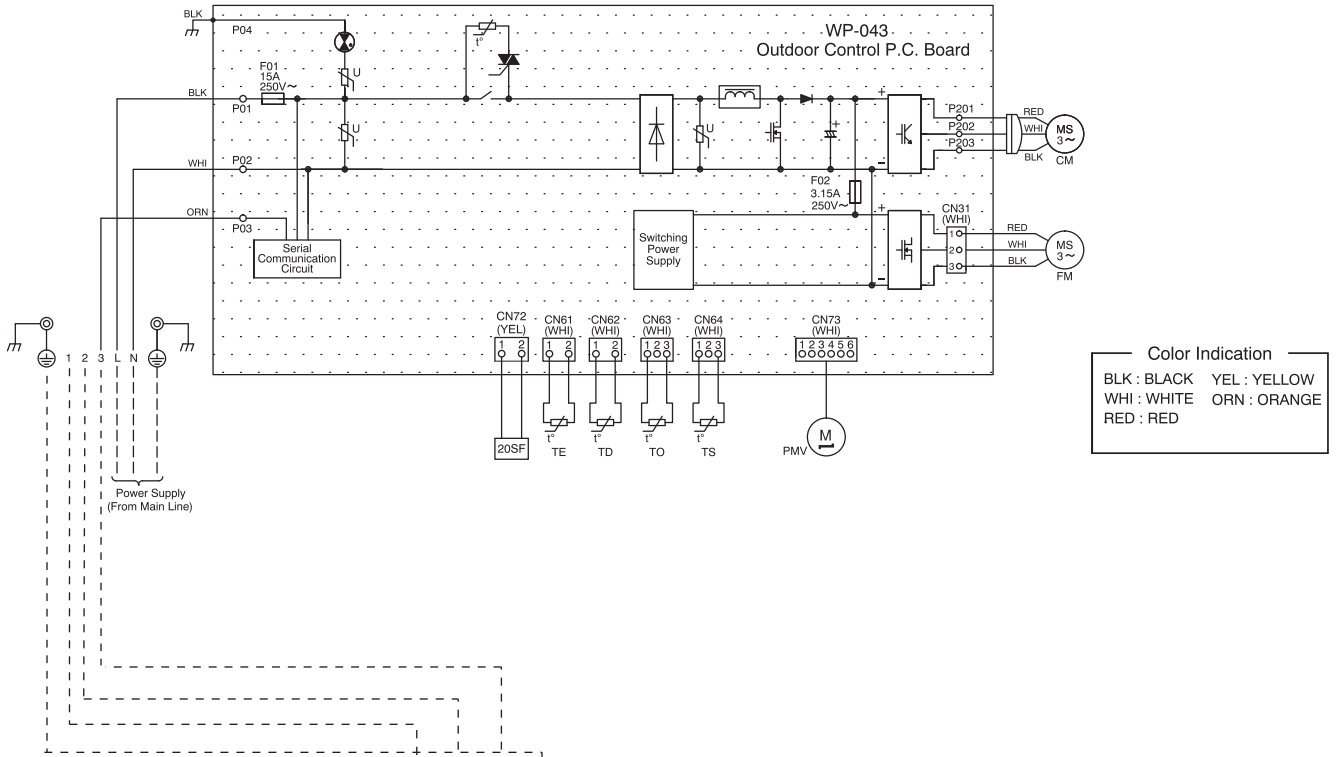

RAS-18J2FVG-TR / RAS-18J2AVSG-TR

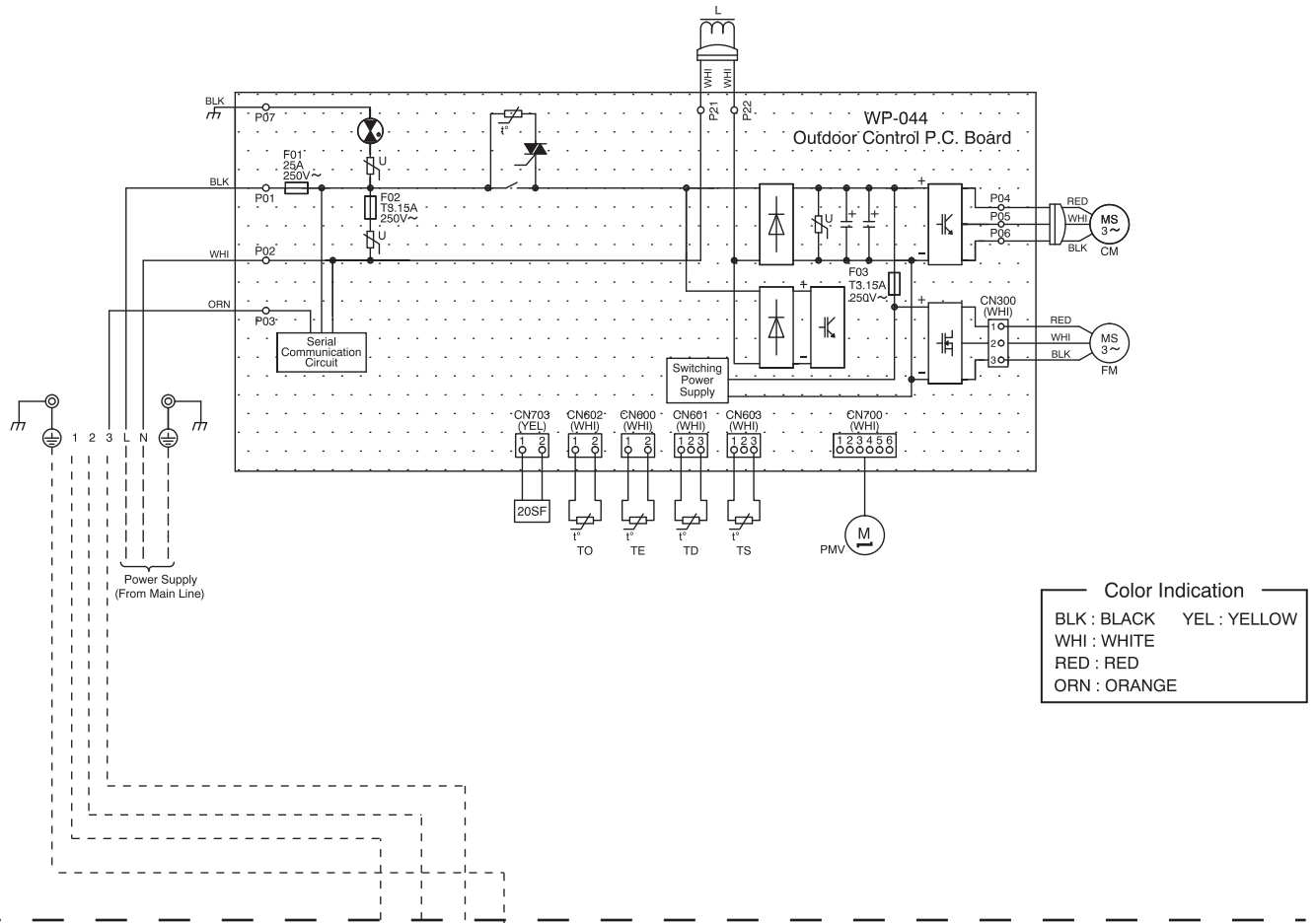

Color Indication  
 BLK : BLACK    YEL : YELLOW  
 WHI : WHITE  
 RED : RED  
 ORN : ORANGE

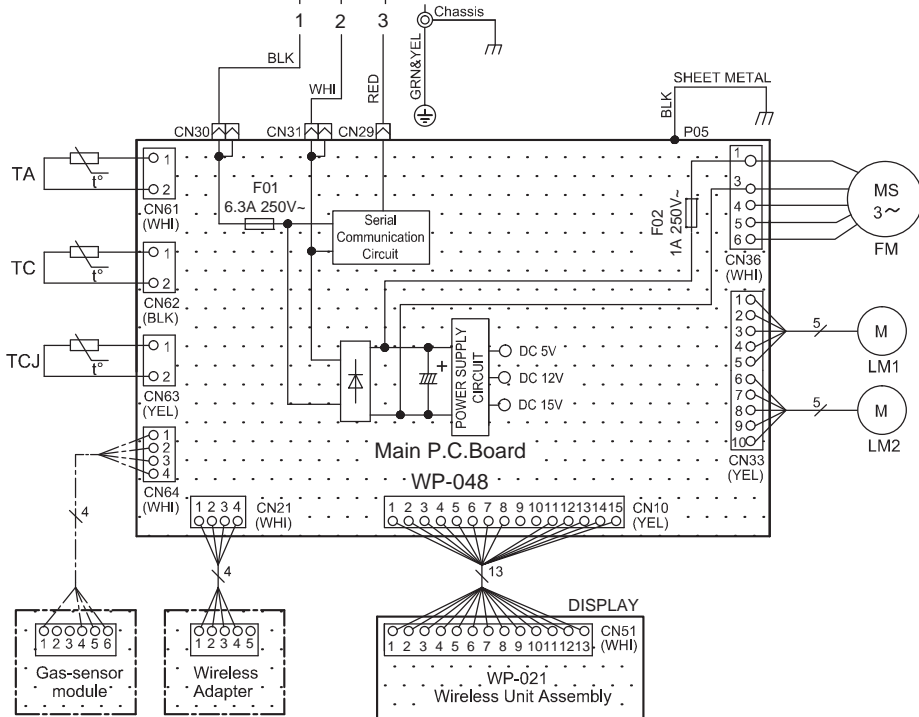

COLOR INDICATION  
 RED : RED  
 WHI : WHITE  
 YEL : YELLOW  
 BLU : BLUE  
 BLK : BLACK  
 GRN&YEL : GREEN&YELLOW

## 6. SPECIFICATIONS OF ELECTRICAL PARTS

### 6-1. Indoor Unit

No.	Parts name	Type	Specifications
1	Fan motor (for indoor)	ICF-340-41-1	DC340, 41W
2	Room temp. sensor (TA-sensor)	( - )	10kΩ at 25°C
3	Heat exchanger temp. sensor (TC-sensor)	( - )	10kΩ at 25°C
4	Heat exchanger temp. sensor (TCJ-sensor)	( - )	10kΩ at 25°C
5	Louver motor	MP24Z3N	Output (Rated), 16 poles, DC12V
6	Dumper motor	MP24Z3N	Output (Rated), 16 poles, DC12V

### 6-2. Outdoor Unit

No.	Parts name	Type name	Specifications	
1	Compressor	RAS-10	KSK75D43UEZA	3-Phases (6-Poles) ; 610W
		RAS-13	KSK89D53UFZ	3-Phases (6-Poles) ; 715W
		RAS-18	KTN130D30UFZ	3-Phases (6-Poles) ; 1075W
2	Fan Motor	WDF-340-A43-1	DC 140-340V ; 43W	
3	Pulse Modulating Valve (PMV) coil	PQ-M10012-000313	DC 12V	
4	4-Way valve coil	RAS-10, 18	SQ-A2522G-000352	AC 220-240V
		RAS-13	DXQ-939	AC 220-240V
5	Reactor	RAS-18	CH-69-Z-T	L = 19mH, 10A
6	Suction temp. sensor (TS sensor)	(Inverter attached)	10kΩ at 25°C	
7	Discharge temp. sensor (TD sensor)	(Inverter attached)	62kΩ at 20°C	
8	Outside air temp. sensor (TO sensor)	(Inverter attached)	10kΩ at 25°C	
9	Heat Exchanger temp. sensor (TE sensor)	(Inverter attached)	10kΩ at 25°C	
10	Terminal block (5 poles)	JX0-5B	AC 250V, 20A	

## 7. REFRIGERANT CYCLE DIAGRAM

### 7-1. Refrigerant Cycle Diagram

RAS-10J2FVG-TR / RAS-10J2AVSG-TR, TR1

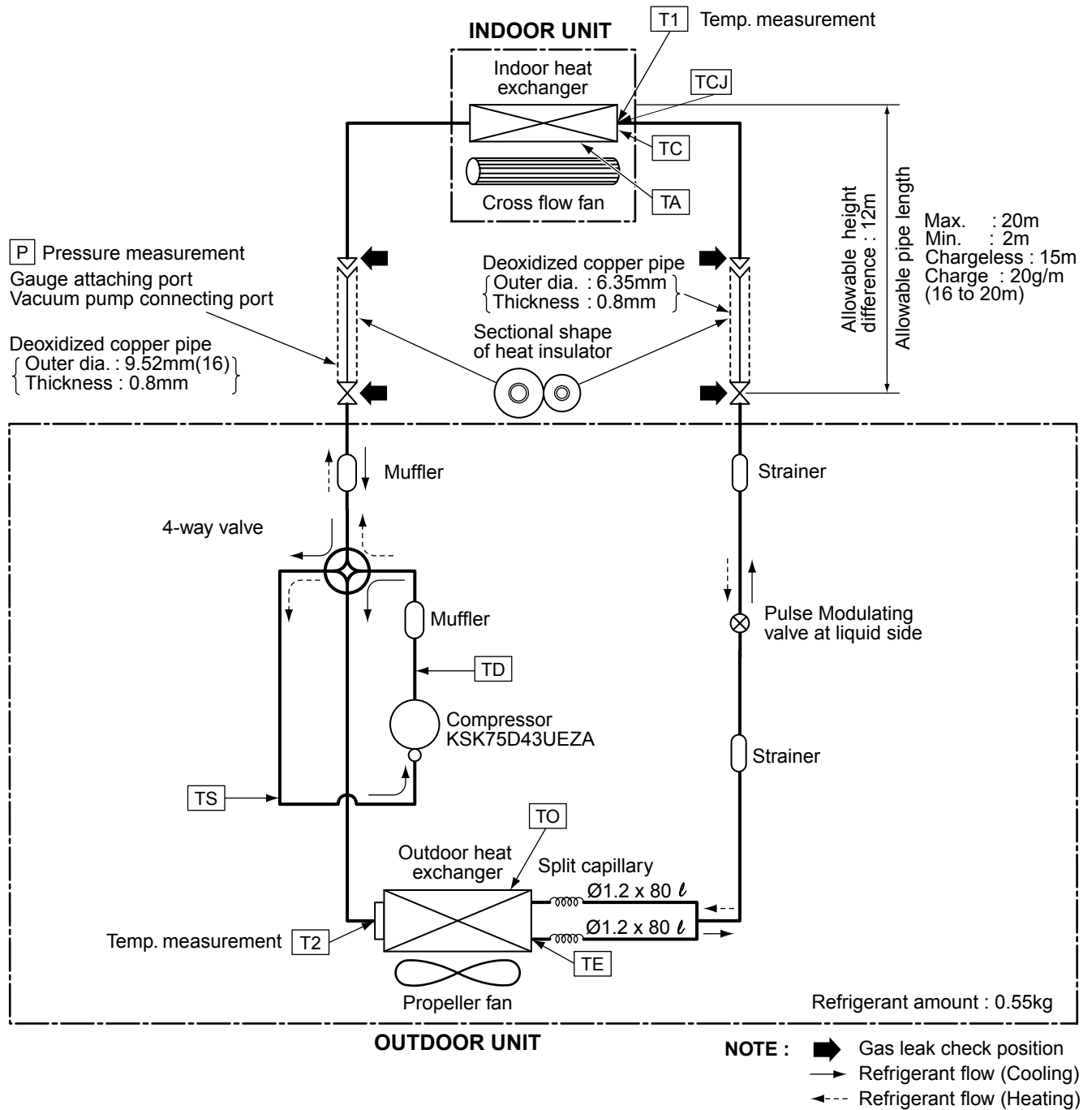

**RAS-13J2FVG-TR / RAS-13J2AVSG-TR, TR1**

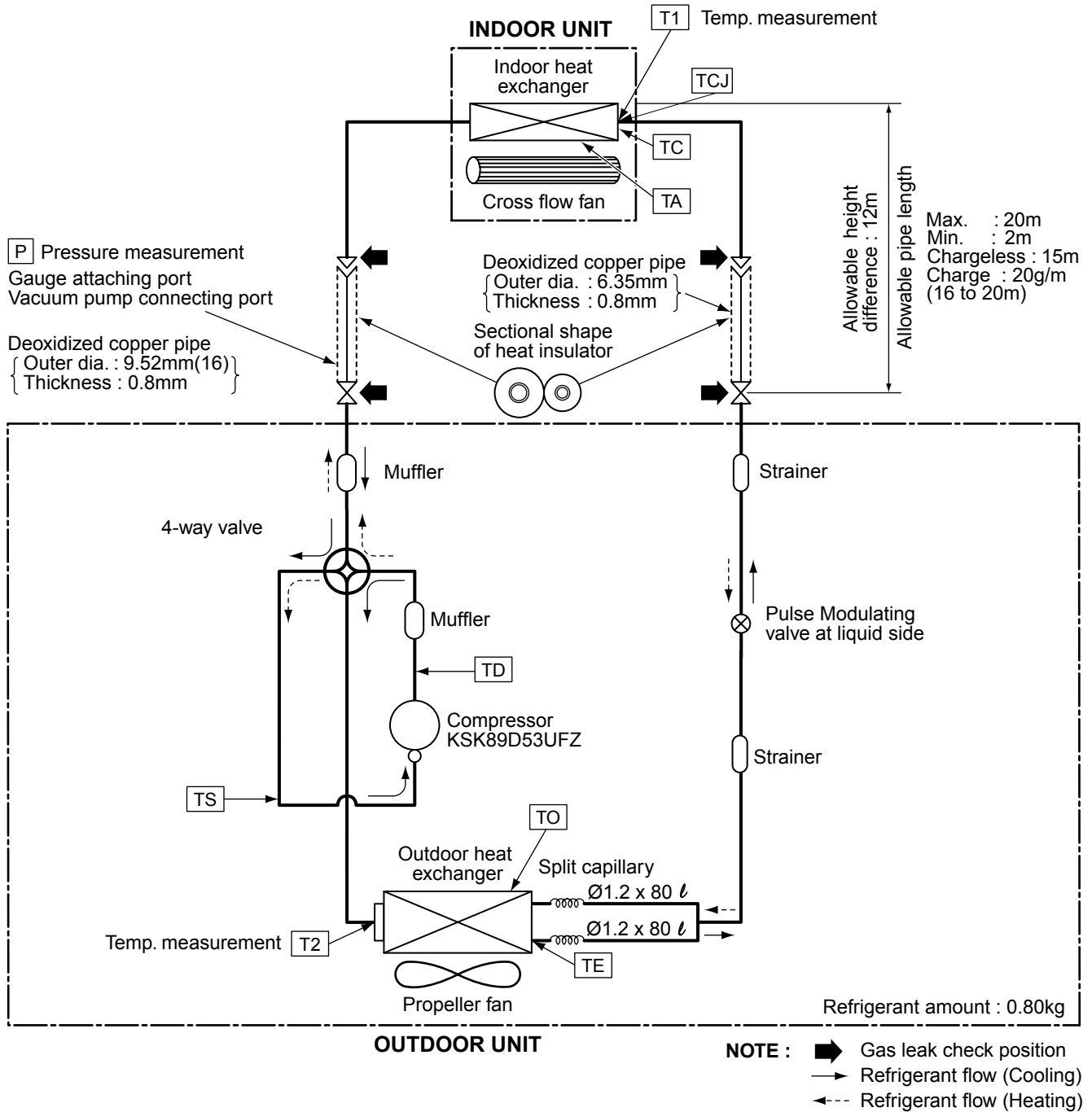

**NOTE :**

- The maximum pipe length of this air conditioner is 20 m. When the pipe length exceeds 15m, the additional charging of refrigerant, 20g per 1m for the part of pipe exceeded 15m is required. (Max. 100g)

**RAS-18J2FVG-TR / RAS-18J2AVSG-TR**

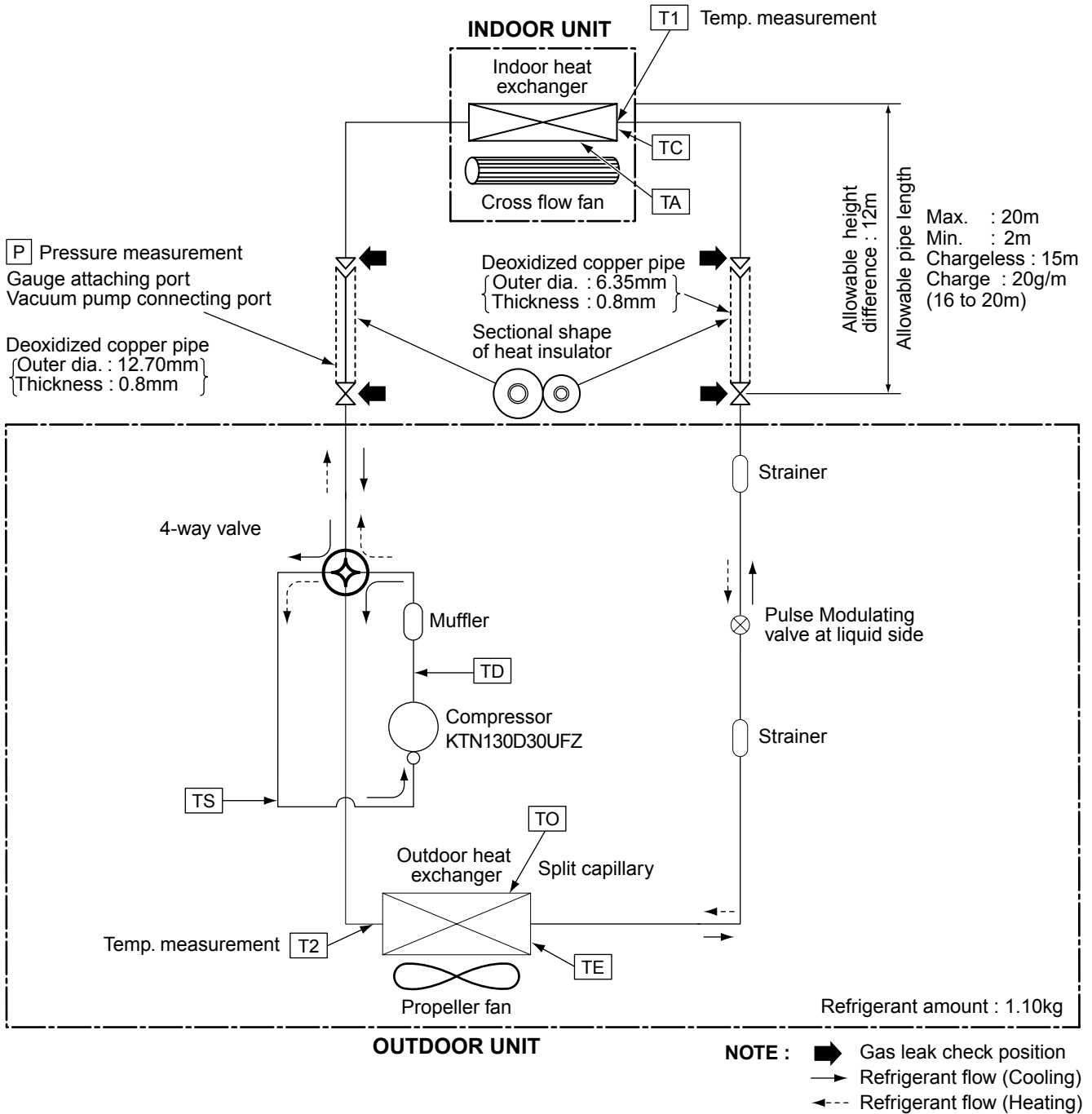

**NOTE :**

- The maximum pipe length of this air conditioner is 20 m. When the pipe length exceeds 15m, the additional charging of refrigerant, 20g per 1m for the part of pipe exceeded 15m is required. (Max. 100g)



## 7-2. Operation Data

### <Cooling>

Temperature condition(°C)		Model name RAS-	Standard pressure P (MPa)	Heat exchanger pipe temp.		Indoor fan mode	Outdoor fan mode	Compressor revolution (rps)	Connecting piping (m)
Indoor	Outdoor			T1 (°C)	T2 (°C)				
27/19	35/-	10J2FVG-TR	0.9-1.1	10 to 11	40 to 43	High	High	53	5
		13J2FVG-TR	1.1-1.2	10 to 12	43 to 45	High	High	66	
		18J2FVG-TR	1.0-1.2	10 to 12	43 to 45	High	High	77	

### <Heating>

Temperature condition(°C)		Model name RAS-	Standard pressure P (MPa)	Heat exchanger pipe temp.		Indoor fan mode	Outdoor fan mode	Compressor revolution (rps)	Connecting piping (m)
Indoor	Outdoor			T1 (°C)	T2 (°C)				
20/-	7/6	10J2FVG-TR	2.3-2.4	38 to 41	1 to 2	High	High	76	5
		13J2FVG-TR	2.4-2.5	40 to 42	0 to 1	High	High	86	
		18J2FVG-TR	2.6-2.8	43 to 45	0 to 1	High	High	83	

**NOTES** : Measure surface temperature of heat exchanger pipe around center of heat exchanger path U bent.  
(Thermistor thermometer)

## 8. CONTROL BLOCK DIAGRAM

### 8-1. Indoor Unit

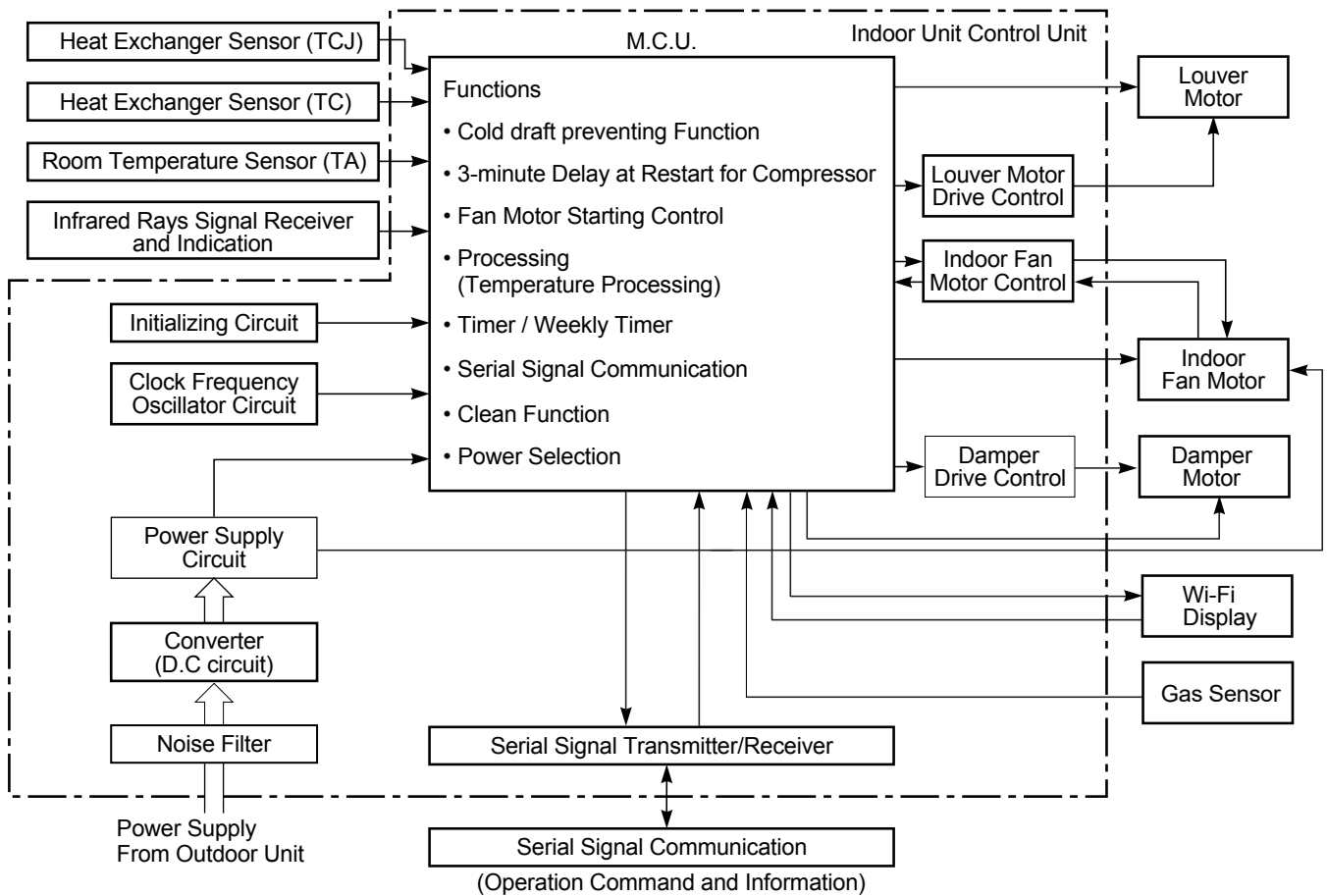

### REMOTE CONTROL

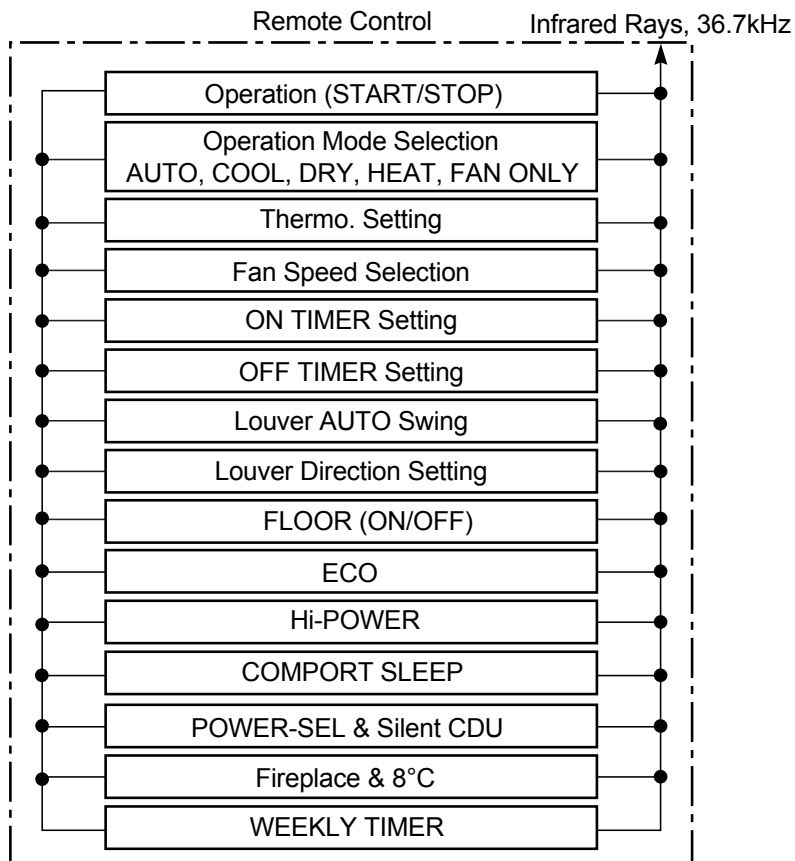

## 8-2. Outdoor Unit (Inverter Assembly)

RAS-10J2FVG-TR / RAS-10J2AVSG-TR  
RAS-13J2FVG-TR / RAS-13J2AVSG-TR

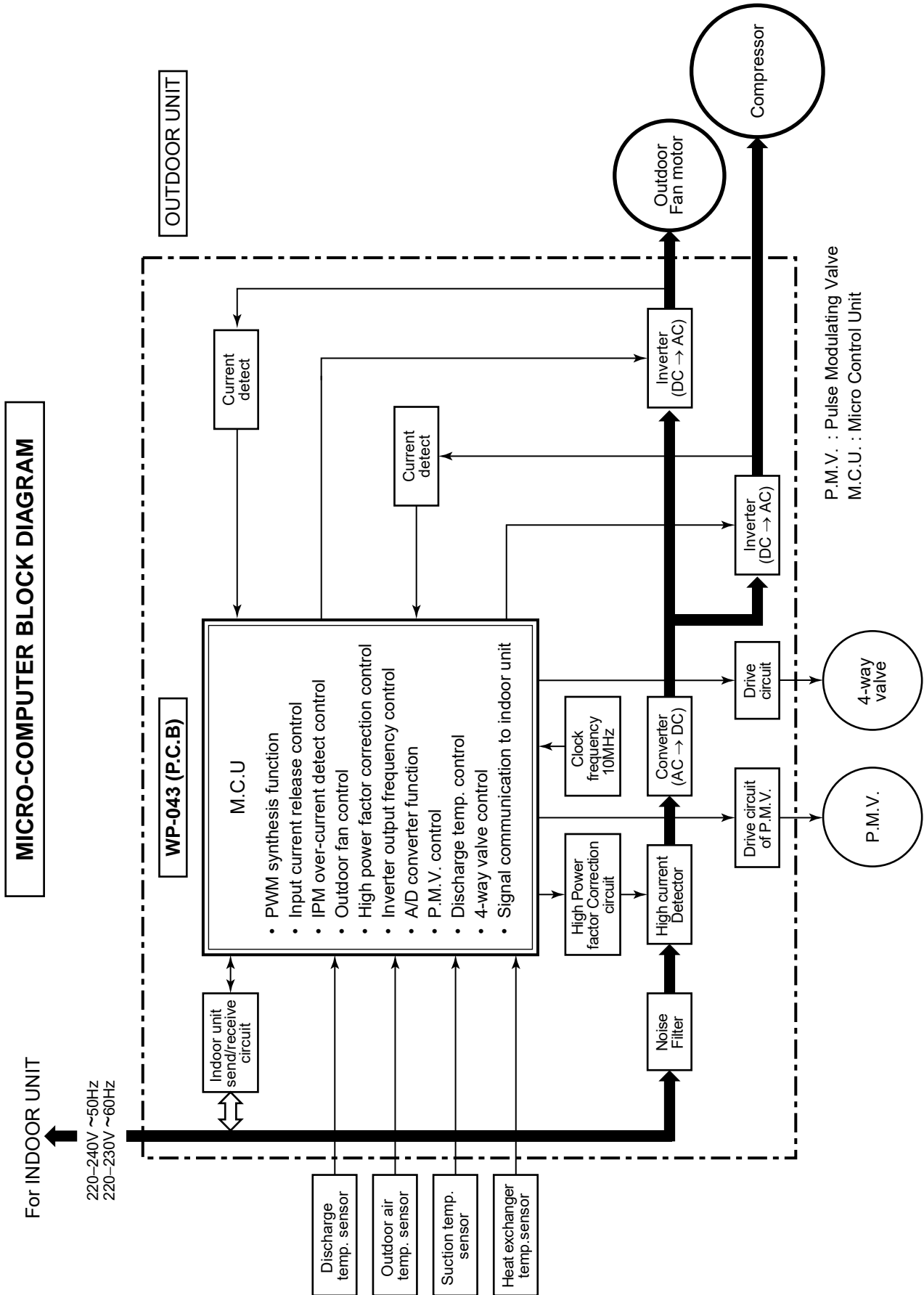

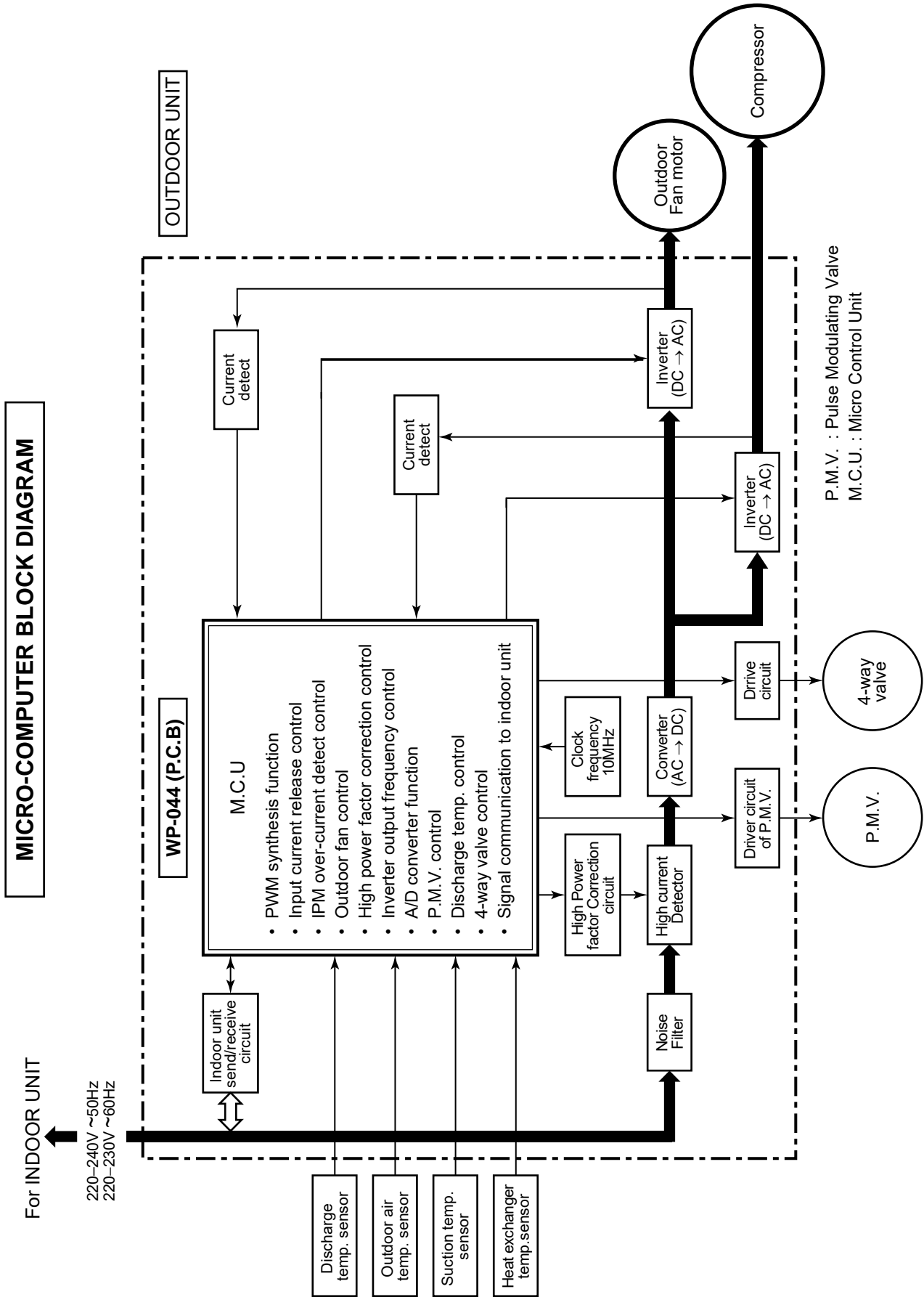

## 9. OPERATION DESCRIPTION

### 9-1. Outline of Air Conditioner Control

This air conditioner is a capacity-variable type air conditioner. Its system can control the speed of compressor motor according to load. The drive circuit for the indoor motor is mounted in the indoor unit. The drive circuits for outdoor motor and compressor are mounted in the outdoor unit.

The entire air conditioner is mainly controlled by the indoor unit controller. The indoor unit controller drives the indoor fan motor based upon command sent from the remote controller. Moreover, it also determines required speed of compressor motor and then transfers the operation command to the outdoor unit controller.

The outdoor unit controller receives operation command from the indoor unit and controls revolution speed of the compressor motor.

The outdoor unit controller controls speed of compressor motor by controlling output voltage of the inverter and switching timing of supply power (current transfer timing), so that compressor motor operates according to the operation command. And then, the outdoor unit controller transfers the operating status back to the indoor unit controller.

**As the compressor adopts six-poles brushless DC motor, the frequency of the supply power from inverter to compressor is three-times cycles of the actual number of revolution.**

#### 1. Role of indoor unit controller

The indoor unit controller judges the operation commands from the remote controller and assumes the following functions.

- Judgment of suction air temperature of the indoor heat exchanger by using the indoor temp. sensor. (TA sensor)
- Judgment of the indoor heat exchanger temperature by using heat exchanger sensor (TC sensor) (Prevent-freezing control, etc.)
- Louver motor control
- Indoor fan motor operation control
- LED (Light Emitting Diode) display control
- Transferring of operation command signal (Serial signal) to the outdoor unit
- Reception of information of operation status (Serial signal including outside temp. data) from the outdoor unit and judgment/display of error

#### 2. Role of outdoor unit controller

Receiving the operation command signal (Serial signal) from the indoor unit controller, the outdoor unit performs compressor operation control as followed to judgment of serial signal from indoor side.

- Detection of inverter input current and current release operation
- Over-current detection and prevention operation to IGBT module (Compressor stop function)
- Compressor and outdoor fan stop function when serial signal is off (when the serial signal does not reach the board assembly of outdoor control by trouble of the signal system)
- Transferring of operation information (Serial signal) from outdoor unit controller to indoor unit controller
- Detection of outdoor temperature and operation revolution control
- Defrost control in heating operation (Temp. measurement by outdoor heat exchanger and control for 4-way valve and outdoor fan)

#### 3. Contents of operation command signal (Serial signal) from indoor unit controller to outdoor unit controller

The following three types of signals are sent from the indoor unit controller.

- Operation mode set on the remote controller
- Compressor revolution command signal defined by indoor temperature and set temperature (Correction along with variation of room temperature and correction of indoor heat exchanger temperature are added.)
- Temperature of indoor heat exchanger
- For these signals ([Operation mode] and [Compressor revolution] indoor heat exchanger temperature), the outdoor unit controller monitors the input current to the inverter, and performs the followed operation within the range that current does not exceed the allowable value.

#### 4. Contents of operation command signal (Serial signal) from outdoor unit controller to indoor unit controller

The following signals are sent from the outdoor unit controller.

- The current operation mode
  - The current compressor revolution
  - Outdoor temperature
  - Existence of protective circuit operation
- For transferring of these signals, the indoor unit controller monitors the contents of signals, and judges existence of trouble occurrence. Contents of judgment are described below.
- Whether distinction of the current operation status meets to the operation command signal
  - Whether protective circuit operates
- When no signal is received from the outdoor unit controller, it is assumed as a trouble.

## 9-2. Operation Description

1. Basic operation .....	31
1. Operation control .....	31
2. Cooling/Heating operation .....	32
3. AUTO operation .....	32
4. DRY operation .....	33
2. Indoor fan motor control .....	34
3. Outdoor fan motor control .....	37
4. Capacity control .....	38
5. Current release control .....	38
6. Release protective control by temperature of indoor heat exchanger .....	39
7. Defrost control (Only in heating operation) .....	40
8. Air outlet selection .....	41
9. Lower air outlet louver control .....	42
10. Upper air outlet louver control .....	43
11. ECO operation .....	44
12. Test operation .....	45
13. Discharge temperature control .....	45
14. High pressure control .....	45
15. Pulse Modulating valve (P.M.V.) control .....	46
16. Self-Cleaning function .....	47
17. Self-Cleaning function release .....	48
18. Remote-A or B selection .....	49
19. QUIET mode .....	49
20. COMFORT SLEEP .....	49
21. Short Timer .....	50
22. Hi-POWER Mode .....	50
23. POWER Selection Mode .....	51
24. Silent Operation .....	51
25. Outdoor Quiet control .....	52
26. Operation mode Selectable .....	52
27. Fireplace Operation .....	53
28. 8°C heating / Frost protective Operation .....	53
29. Set temp. correction .....	54
30. Outdoor Quiet Control .....	55

## 9-3. Auto Restart Function

9-3-1. How to Set the Auto Restart Function .....	57
9-3-2. How to Cancel the Auto Restart Function .....	58
9-3-3. Power Failure During Timer Operation .....	58

## 9-4. Remote Control

9-4-1. Remote control and its functions .....	59
9-4-2. Operation of remote control .....	59
9-4-3. Name and Functions of Indications on Remote Controller .....	67

## 9-5. Indoor Unit Display & Unit Operation Panel .....

68

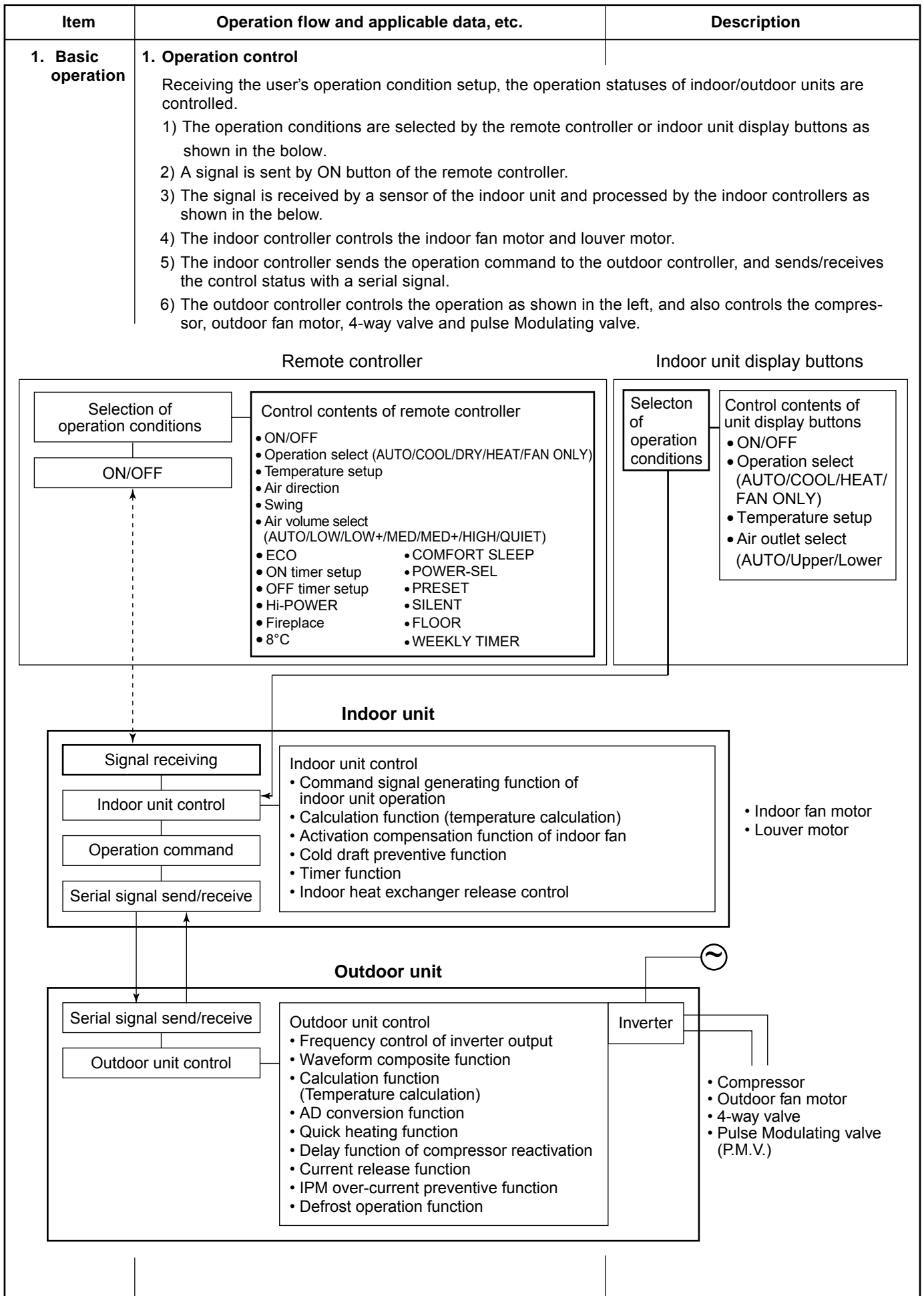

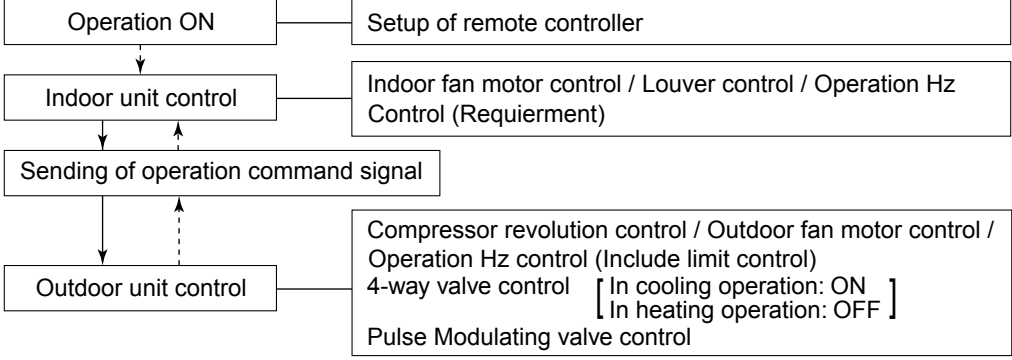
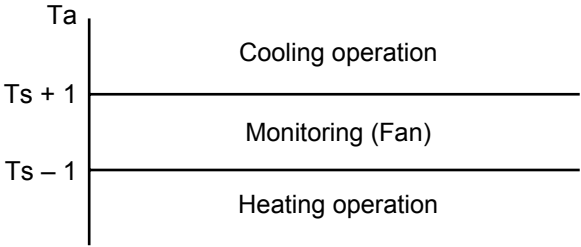
Item	Operation flow and applicable data, etc.	Description
<p><b>1. Basic operation</b></p>	<p><b>2. Cooling/Heating operation</b></p> <p>The operations are performed in the following parts by controls according to cooling/heating conditions.</p> <ol style="list-style-type: none"> <li>1) Receiving the operation ON signal of the remote controller, the cooling or heating operation signal starts being transferred from the indoor controller to the outdoor unit.</li> <li>2) At the indoor unit side, the indoor fan is operated according to the contents of “<b>2. Indoor fan motor control</b>” and the louver according to the contents of “<b>9. Louver control</b>”, respectively.</li> <li>3) The outdoor unit controls the outdoor fan motor, compressor, pulse Modulating valve and 4-way valve according to the operation signal sent from the indoor unit.</li> </ol> 	
	<p><b>3. AUTO operation</b></p> <p>Selection of operation mode As shown in the following figure, the operation starts by selecting automatically the status of room temperature (TA) when starting AUTO operation.</p> <p>*1. When reselecting the operation mode, the fan speed is controlled by the previous operation mode.</p> 	<ol style="list-style-type: none"> <li>1) Detects the room temperature (TA) when the operation started.</li> <li>2) Selects an operation mode from TA in the left figure.</li> <li>3) Fan operation continues until an operation mode is selected.</li> <li>4) When AUTO operation has started within 2 hours after heating operation stopped and if the room temperature is 20°C or more, the fan operation is performed with "Super Ultra LOW" mode for 3 minutes. Then, select an operation mode.</li> <li>5) If the status of compressor-OFF continues for 15 minutes the room temperature after selecting an operation mode (COOL/HEAT), reselect an operation mode.</li> </ol>

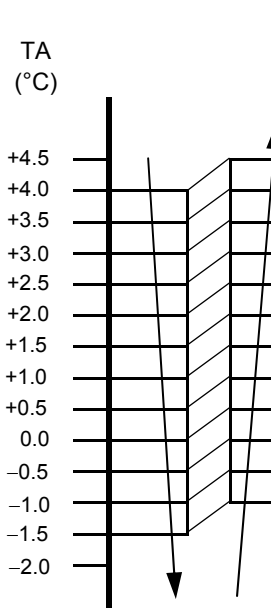

Item	Operation flow and applicable data, etc.	Description																																																																												
<b>1. Basic operation</b>	<p><b>4. DRY operation</b></p> <p>DRY operation is performed according to the difference between room temperature and the setup temperature as shown below.</p> <p>In DRY operation, fan speed is controlled in order to prevent lowering of the room temperature.</p>	<p>1) Detects the room temperature (TA) when the DRY operation started.</p> <p>2) Starts operation under conditions in the left figure according to the temperature difference between the room temperature and the setup temperature (Tsc). Setup temperature (Tsc) = Set temperature on remote controller (Ts) + (-1.0 to 0.0)</p> <p>3) When the room temperature is lower 2°C or less than the setup temperature, turn off the compressor.</p> <p>4) The time correction is performed every 8 minutes.</p>																																																																												
 <table border="1" data-bbox="638 694 1404 1299"> <thead> <tr> <th rowspan="2">Zone</th> <th colspan="3">Compressor speed (rps)</th> <th rowspan="2">Fan speed</th> <th rowspan="2">Time correction</th> </tr> <tr> <th>10J2FVG-TR</th> <th>13J2FVG-TR</th> <th>18J2FVG-TR</th> </tr> </thead> <tbody> <tr> <td>12</td> <td>35</td> <td>37</td> <td>49</td> <td>W8</td> <td rowspan="6">+1 zone</td> </tr> <tr> <td>11</td> <td>32</td> <td>34</td> <td>42</td> <td>W6</td> </tr> <tr> <td>10</td> <td>30</td> <td>31</td> <td>36</td> <td rowspan="4">W5</td> </tr> <tr> <td>9</td> <td>27</td> <td>28</td> <td>30</td> </tr> <tr> <td>8</td> <td>25</td> <td>26</td> <td>24</td> </tr> <tr> <td>7</td> <td>22</td> <td>23</td> <td>18</td> </tr> <tr> <td>6</td> <td>20</td> <td>20</td> <td>11</td> <td rowspan="2">W4</td> <td>±0</td> </tr> <tr> <td>5</td> <td></td> <td></td> <td></td> <td></td> </tr> <tr> <td>4</td> <td></td> <td></td> <td></td> <td></td> <td rowspan="3">-1 zone (min 1)</td> </tr> <tr> <td>3</td> <td></td> <td></td> <td></td> <td></td> </tr> <tr> <td>2</td> <td></td> <td></td> <td></td> <td></td> </tr> <tr> <td>1</td> <td></td> <td></td> <td></td> <td></td> <td></td> </tr> <tr> <td>0</td> <td>OFF</td> <td>OFF</td> <td>OFF</td> <td></td> <td></td> </tr> </tbody> </table>			Zone	Compressor speed (rps)			Fan speed	Time correction	10J2FVG-TR	13J2FVG-TR	18J2FVG-TR	12	35	37	49	W8	+1 zone	11	32	34	42	W6	10	30	31	36	W5	9	27	28	30	8	25	26	24	7	22	23	18	6	20	20	11	W4	±0	5					4					-1 zone (min 1)	3					2					1						0	OFF	OFF	OFF		
Zone	Compressor speed (rps)			Fan speed	Time correction																																																																									
	10J2FVG-TR	13J2FVG-TR	18J2FVG-TR																																																																											
12	35	37	49	W8	+1 zone																																																																									
11	32	34	42	W6																																																																										
10	30	31	36	W5																																																																										
9	27	28	30																																																																											
8	25	26	24																																																																											
7	22	23	18																																																																											
6	20	20	11	W4	±0																																																																									
5																																																																														
4					-1 zone (min 1)																																																																									
3																																																																														
2																																																																														
1																																																																														
0	OFF	OFF	OFF																																																																											

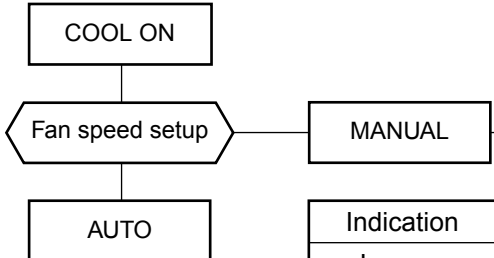
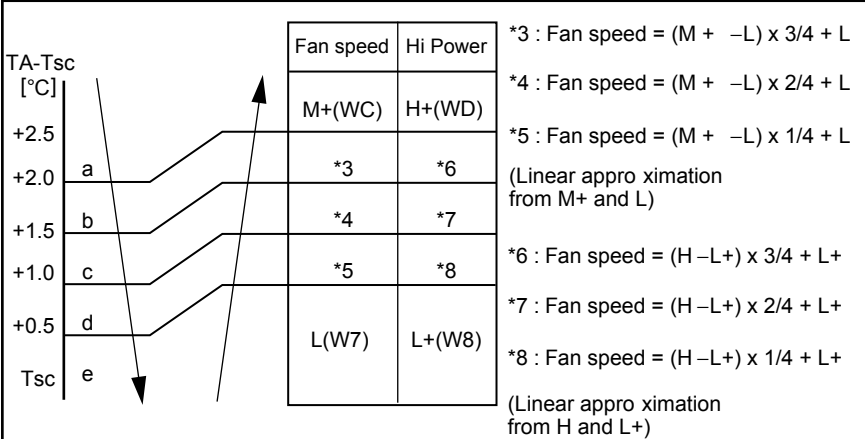
Item	Operation flow and applicable data, etc.	Description																																																																																																																																						
2. Indoor fan motor control	<p><b>&lt;In cooling operation&gt;</b>            (This operation controls the fan speed at indoor unit side.)            The indoor fan (cross flow fan) is operated by the phase-control induction motor. The fan rotates in 5 stages in MANUAL mode, and in 5 stages in AUTO mode, respectively. (Table 1)</p>	<p><b>* Symbols</b></p> <p>UH : Ultra High            H : High            M+ : Medium+            M : Medium            L+ : Low+            L : Low            L- : Low-            UL : Ultra Low            SUL : Super Ultra Low</p> <p>* The fan speed broadly varies due to position of the louver, etc.            The described value indicates one under condition of inclining downward blowing.</p> <p>1) When setting the fan speed to L, L+, M, M+ or H on the remote controller, the operation is performed with the constant speed shown in Fig. 1.</p> <p>2) When setting the fan speed to AUTO on the remote controller, revolution of the fan motor is controlled to the fan speed level shown in Fig. 2 and Table 1 according to the setup temperature, room temperature, and heat exchanger temperature.</p>																																																																																																																																						
	 <p style="text-align: right;">(Fig. 1)</p> <table border="1" style="margin-left: auto; margin-right: auto;"> <thead> <tr> <th>Indication</th> <th>Fan speed</th> <th>Hi-POWER</th> </tr> </thead> <tbody> <tr> <td>L </td> <td>W7</td> <td>W8</td> </tr> <tr> <td>L+ </td> <td>(L + M) / 2</td> <td>(L + M) / 2</td> </tr> <tr> <td>M </td> <td>WA</td> <td>WC</td> </tr> <tr> <td>M+ </td> <td>(M + H) / 2</td> <td>(M + H) / 2</td> </tr> <tr> <td>H </td> <td>WD</td> <td>WE</td> </tr> </tbody> </table> <p style="text-align: center;">(Fig. 2)</p> 		Indication	Fan speed	Hi-POWER	L	W7	W8	L+	(L + M) / 2	(L + M) / 2	M	WA	WC	M+	(M + H) / 2	(M + H) / 2	H	WD	WE																																																																																																																				
Indication	Fan speed	Hi-POWER																																																																																																																																						
L	W7	W8																																																																																																																																						
L+	(L + M) / 2	(L + M) / 2																																																																																																																																						
M	WA	WC																																																																																																																																						
M+	(M + H) / 2	(M + H) / 2																																																																																																																																						
H	WD	WE																																																																																																																																						
<p><b>(table 1) Indoor fan air flow rate &lt;Cooling&gt;</b></p> <table border="1" style="width: 100%; border-collapse: collapse; text-align: center;"> <thead> <tr> <th rowspan="2">Fan speed level</th> <th rowspan="2">Cool</th> <th colspan="2">RAS-10J2FVG-TR</th> <th colspan="2">RAS-13J2FVG-TR</th> <th colspan="2">RAS-18J2FVG-TR</th> </tr> <tr> <th>Fan speed (rpm)</th> <th>Air flow rate (m3/h)</th> <th>Fan speed (rpm)</th> <th>Air flow rate (m3/h)</th> <th>Fan speed (rpm)</th> <th>Air flow rate (m3/h)</th> </tr> </thead> <tbody> <tr><td>WF</td><td>UH</td><td>530</td><td>498</td><td>560</td><td>528</td><td>650</td><td>624</td></tr> <tr><td>WE</td><td>H</td><td>530</td><td>498</td><td>560</td><td>528</td><td>650</td><td>624</td></tr> <tr><td>WD</td><td>M+</td><td>530</td><td>498</td><td>550</td><td>519</td><td>630</td><td>600</td></tr> <tr><td>WC</td><td></td><td>480</td><td>447</td><td>500</td><td>468</td><td>560</td><td>528</td></tr> <tr><td>WB</td><td>M</td><td>450</td><td>414</td><td>490</td><td>459</td><td>560</td><td>528</td></tr> <tr><td>WA</td><td></td><td>400</td><td>366</td><td>440</td><td>408</td><td>500</td><td>468</td></tr> <tr><td>W9</td><td>L+</td><td>360</td><td>324</td><td>390</td><td>354</td><td>450</td><td>414</td></tr> <tr><td>W8</td><td>L</td><td>350</td><td>315</td><td>390</td><td>354</td><td>450</td><td>414</td></tr> <tr><td>W7</td><td>L-</td><td>300</td><td>258</td><td>340</td><td>300</td><td>400</td><td>366</td></tr> <tr><td>W6</td><td></td><td>260</td><td>216</td><td>270</td><td>228</td><td>360</td><td>324</td></tr> <tr><td>W5</td><td>UL</td><td>260</td><td>216</td><td>270</td><td>228</td><td>340</td><td>300</td></tr> <tr><td>W4</td><td></td><td>240</td><td>198</td><td>250</td><td>210</td><td>320</td><td>282</td></tr> <tr><td>W3</td><td></td><td>240</td><td>198</td><td>240</td><td>198</td><td>300</td><td>258</td></tr> <tr><td>W2</td><td>SUL</td><td>240</td><td>198</td><td>240</td><td>198</td><td>300</td><td>258</td></tr> <tr><td>W1</td><td></td><td>240</td><td>198</td><td>240</td><td>198</td><td>300</td><td>258</td></tr> </tbody> </table>			Fan speed level	Cool	RAS-10J2FVG-TR		RAS-13J2FVG-TR		RAS-18J2FVG-TR		Fan speed (rpm)	Air flow rate (m3/h)	Fan speed (rpm)	Air flow rate (m3/h)	Fan speed (rpm)	Air flow rate (m3/h)	WF	UH	530	498	560	528	650	624	WE	H	530	498	560	528	650	624	WD	M+	530	498	550	519	630	600	WC		480	447	500	468	560	528	WB	M	450	414	490	459	560	528	WA		400	366	440	408	500	468	W9	L+	360	324	390	354	450	414	W8	L	350	315	390	354	450	414	W7	L-	300	258	340	300	400	366	W6		260	216	270	228	360	324	W5	UL	260	216	270	228	340	300	W4		240	198	250	210	320	282	W3		240	198	240	198	300	258	W2	SUL	240	198	240	198	300	258	W1		240	198	240	198	300	258
Fan speed level	Cool	RAS-10J2FVG-TR			RAS-13J2FVG-TR		RAS-18J2FVG-TR																																																																																																																																	
		Fan speed (rpm)	Air flow rate (m3/h)	Fan speed (rpm)	Air flow rate (m3/h)	Fan speed (rpm)	Air flow rate (m3/h)																																																																																																																																	
WF	UH	530	498	560	528	650	624																																																																																																																																	
WE	H	530	498	560	528	650	624																																																																																																																																	
WD	M+	530	498	550	519	630	600																																																																																																																																	
WC		480	447	500	468	560	528																																																																																																																																	
WB	M	450	414	490	459	560	528																																																																																																																																	
WA		400	366	440	408	500	468																																																																																																																																	
W9	L+	360	324	390	354	450	414																																																																																																																																	
W8	L	350	315	390	354	450	414																																																																																																																																	
W7	L-	300	258	340	300	400	366																																																																																																																																	
W6		260	216	270	228	360	324																																																																																																																																	
W5	UL	260	216	270	228	340	300																																																																																																																																	
W4		240	198	250	210	320	282																																																																																																																																	
W3		240	198	240	198	300	258																																																																																																																																	
W2	SUL	240	198	240	198	300	258																																																																																																																																	
W1		240	198	240	198	300	258																																																																																																																																	

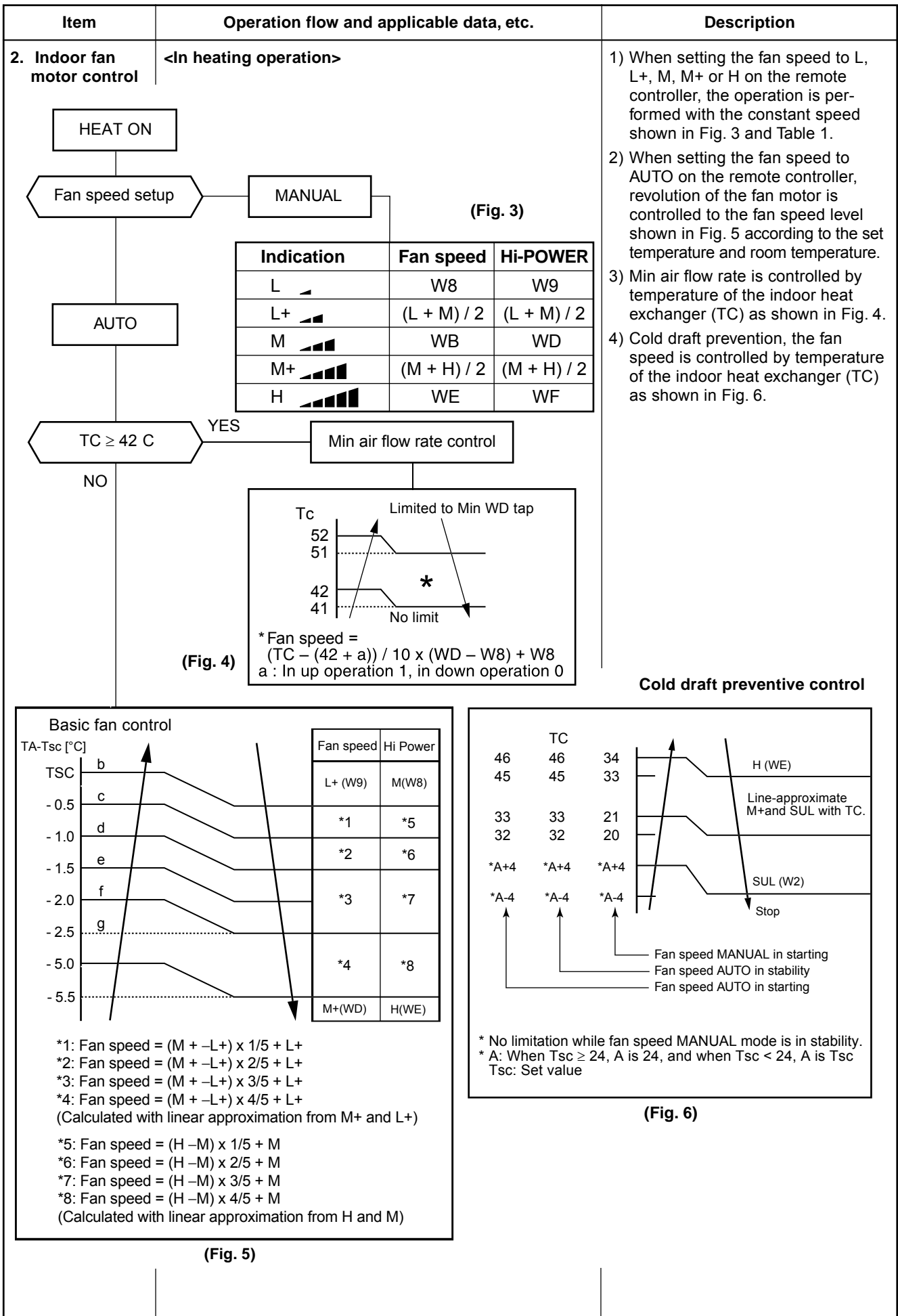

Item	Operation flow and applicable data, etc.	Description
<b>2. Indoor fan motor control</b>		
<b>[In starting and in stability]</b>		
	<b>In starting</b>	<b>In stability</b>
FAN AUTO	<ul style="list-style-type: none"> <li>• Until 12 minutes passed after operation start</li> <li>• When 12 to 25 minutes passed after operation start and room temp. is 3°C or lower than set temp.</li> </ul>	<ul style="list-style-type: none"> <li>• When 12 to 25 minutes passed after operation start and room temp. is higher than (set temp. -3°C)</li> <li>• When 25 minutes or more passed after operation start</li> </ul>
FAN Manual	• Room temp. < Set temp. -4°C	• Room temp. = Set temp. -3.5°C

**(Table 2) Indoor fan air flow rate <Heating>**

Fan speed level	HEAT	RAS-10J2FVG-TR		RAS-13J2FVG-TR		RAS-18J2FVG-TR	
		Fan speed (rpm)	Air flow rate (m3/h)	Fan speed (rpm)	Air flow rate (m3/h)	Fan speed (rpm)	Air flow rate (m3/h)
WF	UH	560	528	600	570	700	675
WE	H	560	528	580	552	700	675
WD	M+	480	443	520	486	590	570
WC		440	408	470	435	570	540
WB	M	400	366	460	426	500	467
WA		380	342	410	376	460	426
W9	L+	370	334	400	366	460	426
W8	L	320	282	340	300	400	366
W7	L-	260	216	270	228	360	324
W6		260	216	270	228	340	300
W5	UL	260	216	270	228	340	300
W4		260	216	270	228	340	300
W3		260	216	270	228	340	300
W2	SUL	240	198	250	210	320	282
W1		240	198	240	198	240	198

Item	Operation flow and applicable data, etc.	Description
3. Outdoor fan motor control	<p>The blowing air volume at the outdoor unit side is controlled. Receiving the operation command from the controller of indoor unit, the controller of outdoor unit controls fan speed.</p> <p>* For the fan motor, a DC motor with non-stage variable speed system is used. However, it is limited to 8 stages for reasons of controlling.</p> <pre> graph TD     A[Air conditioner ON (Remote controller)] --&gt; B[Indoor unit controller]     B --&gt; C[1) Outdoor unit operation command (Outdoor fan control)]     C --&gt; D{2) Fan speed ≥ 400 when the motor stopped.}     D -- YES --&gt; E[OFF status of fan motor continues.]     D -- NO --&gt; F[Fan motor ON]     F --&gt; G{3) Fan lock}     G -- YES --&gt; H[Air conditioner OFF]     H --&gt; I[Alarm display]     G -- NO --&gt; J[4) Motor operates as shown in the table below.]           </pre>	<ol style="list-style-type: none"> <li>The operation command sent from the remote controller is processed by the indoor unit controller and transferred to the controller of the outdoor unit.</li> <li>When strong wind blows at outdoor side, the operation of air conditioner continues with the fan motor stopped.</li> <li>Whether the fan is locked or not is detected, and the operation of air conditioner stops and an alarm is displayed if the fan is locked.</li> <li>According to each operation mode, by the conditions of outdoor temperature (To) and compressor revolution, the speed of the outdoor fan shown in the table is selected.</li> </ol>

In cooling operation							
Compressor speed	RAS-10J2AVSG-TR,TR1	Hz < 21.6		21.6 ≤ Hz < 49.2		49.2 ≤ Hz	
	RAS-13J2AVSG-TR,TR1	Hz < 21.6		21.6 ≤ Hz < 66.6		66.6 ≤ Hz	
	RAS-18J2AVSG-TR	Hz < 20.4		20.4 ≤ Hz < 30.6		30.6 ≤ Hz	
Fan speed range		MIN	MAX	MIN	MAX	MIN	MAX
To	To ≥ 38°C	f6	fB	f8	fE	fA	fE
	To ≥ 28°C	f5	fA	f7	fE	f9	fE
	To ≥ 15°C	f3	f7	f5	f9	f7	fB
	To ≥ 5.5°C	f2	f5	f4	f7	f6	f9
	To ≥ 0°C	f1	f3	f3	f5	f4	f7
	To ≥ 0°C	f1	f2	f2	f4	f3	f5
When To is abnormal		OFF	fB	OFF	fE	f1	fE

In heating operation							
Compressor speed	RAS-10J2AVSG-TR,TR1	Hz < 21.6		21.6 ≤ Hz < 67.8		67.8 ≤ Hz	
	RAS-13J2AVSG-TR,TR1	Hz < 21.6		21.6 ≤ Hz < 67.8		67.8 ≤ Hz	
	RAS-18J2AVSG-TR	Hz < 20.4		20.4 ≤ Hz < 48.6		48.6 ≤ Hz	
Fan speed range		MIN	MAX	MIN	MAX	MIN	MAX
To	To ≥ 10°C		f7		f8		f9
	To ≥ 5°C		f9		fB		fE
	To ≥ -3°C		fE		fE		fE
	To ≥ -10°C		fE		fE		fE
	To < -10°C		fE		fE		fE
When To is abnormal			fE		fF		fF

### Outdoor fan speed (rpm)

Model name	Fan speed range															
	f0	f1	f2	f3	f4	f5	f6	f7	f8	f9	fA	fB	fC	fD	fE	fF
RAS-10J2AVSG-TR,TR1	0	300	370	390	450	500	520	600	720	750	780	780	800	800	800	800
RAS-13J2AVSG-TR,TR1	0	300	370	390	450	500	520	600	720	750	780	780	860	860	860	860
RAS-18J2AVSG-TR	0	300	300	300	360	450	500	550	600	650	700	800	900	900	900	900

Item	Operation flow and applicable data, etc.	Description																																		
<p><b>4. Capacity control</b></p>	<p>The cooling or heating capacity depending on the load is adjusted.</p> <p>According to difference between the setup value of temperature and the room temperature, the capacity is adjusted by the compressor revolution.</p> <div style="text-align: center;"> <pre> graph TD     Ts[Remote controller: Set temp. (Ts)] --- Diff{Ts - Ta}     Ta[Indoor unit: Room temp. (Ta)] --- Diff     Diff --&gt; Hz[Correction of Hz signal]     Hz --&gt; EMF[Detection of electromotive force of compressor motor winding]     EMF --&gt; Speed[Detection of motor speed and rotor position]     Speed --&gt; Comp[Correction value of Hz signal ≤ Operating Hz]     Comp --&gt; Inverter[Inverter output change Commutation timing change]     Inverter --&gt; SpeedChange[Change of compressor speed]           </pre> </div>	<ol style="list-style-type: none"> <li>1) The difference between set temperature on remote controller (Ts) and room temperature (Ta) is calculated.</li> <li>2) According to the temperature difference, the correction value of Hz signal which determines the compressor speed is set up.</li> <li>3) The rotating position and speed of the motor are detected by the electromotive force occurred on the motor winding with operation of the compressor.</li> <li>4) According to the difference resulted from comparison of the correction value of Hz signal with the present operation Hz, the inverter output and the commutation timing are varied.</li> <li>5) Change the compressor motor speed by outputting power to the compressor.</li> </ol> <p>* The contents of control operation are same in cooling operation and heating operation</p>																																		
<p><b>5. Current release control</b></p>	<p>This function prevents troubles on the electronic parts of the compressor driving inverter.</p> <p>This function also controls drive circuit of the compressor speed so that electric power of the compressor drive circuit does not exceed the specified value.</p> <div style="text-align: center;"> <pre> graph TD     Inverter[Outdoor unit inverter main circuit control current] --- Setup[Setup of current release point]     To[Outdoor temp. To] --- Setup     Setup --&gt; Comp{Operating current ≤ Setup value}     Comp -- High --&gt; Reduce[Reduce compressor speed]     Reduce --&gt; Decrease{Current decrease}     Comp -- Low --&gt; Continue[Capacity control continues.]           </pre> </div> <table border="1" style="margin-top: 20px; width: 100%; border-collapse: collapse;"> <thead> <tr> <th rowspan="2">Mode</th> <th rowspan="2">Outdoor temperature: To (°C)</th> <th colspan="3">Current Release Value (A)</th> </tr> <tr> <th>RAS-10J2FVG-TR</th> <th>RAS-13J2FVG-TR</th> <th>RAS-18J2FVG-TR</th> </tr> </thead> <tbody> <tr> <td rowspan="3">Cooling</td> <td>To ≥ 45</td> <td>5.4</td> <td>5.4</td> <td>6.2</td> </tr> <tr> <td>45 &gt; To ≥ 40</td> <td>5.8</td> <td>5.8</td> <td>6.7</td> </tr> <tr> <td>To &lt; 40</td> <td>4.5</td> <td>6.2</td> <td>9.0</td> </tr> <tr> <td rowspan="3">Heating</td> <td>To ≥ 16</td> <td>6.2</td> <td>8.0</td> <td>10.0</td> </tr> <tr> <td>16 &gt; To ≥ 11</td> <td>6.2</td> <td>8.0</td> <td>10.0</td> </tr> <tr> <td>To &lt; 11</td> <td>6.2</td> <td>8.0</td> <td>10.0</td> </tr> </tbody> </table>	Mode	Outdoor temperature: To (°C)	Current Release Value (A)			RAS-10J2FVG-TR	RAS-13J2FVG-TR	RAS-18J2FVG-TR	Cooling	To ≥ 45	5.4	5.4	6.2	45 > To ≥ 40	5.8	5.8	6.7	To < 40	4.5	6.2	9.0	Heating	To ≥ 16	6.2	8.0	10.0	16 > To ≥ 11	6.2	8.0	10.0	To < 11	6.2	8.0	10.0	<ol style="list-style-type: none"> <li>1) The input current of the outdoor unit is detected in the inverter section of the outdoor unit.</li> <li>2) According to the detected outdoor temperature, the specified value of the current is selected.</li> <li>3) Whether the current value exceeds the specified value or not is judged.</li> <li>4) If the current value exceeds the specified value, this function reduces the compressor speed and controls speed up to the closest one commanded from the indoor unit within the range which does not exceed the specified value.</li> </ol>
Mode	Outdoor temperature: To (°C)			Current Release Value (A)																																
		RAS-10J2FVG-TR	RAS-13J2FVG-TR	RAS-18J2FVG-TR																																
Cooling	To ≥ 45	5.4	5.4	6.2																																
	45 > To ≥ 40	5.8	5.8	6.7																																
	To < 40	4.5	6.2	9.0																																
Heating	To ≥ 16	6.2	8.0	10.0																																
	16 > To ≥ 11	6.2	8.0	10.0																																
	To < 11	6.2	8.0	10.0																																

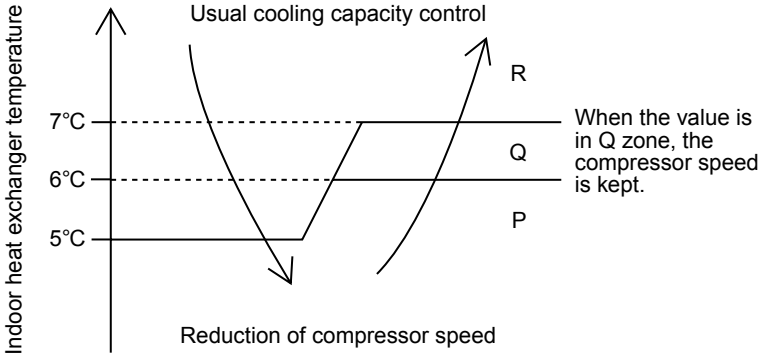
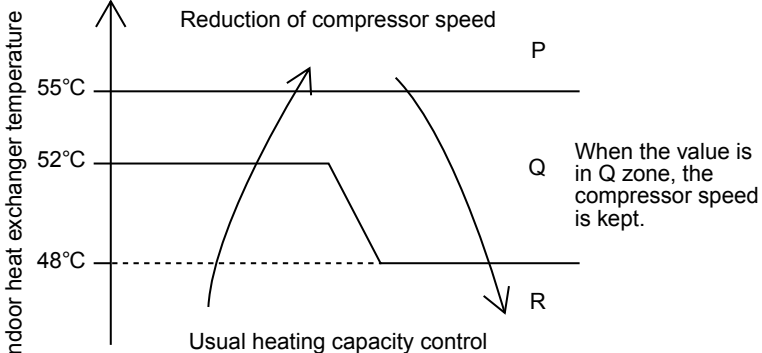
Item	Operation flow and applicable data, etc.	Description
<p><b>6. Release protective control by temperature of indoor heat exchanger</b></p>	<p><b>&lt;In cooling/dry operation&gt;</b>            (Prevent-freezing control for indoor heat exchanger)            In cooling/dry operation, the sensor of indoor heat exchanger detects evaporation temperature and controls the compressor speed so that temperature of the heat exchanger does not exceed the specified value.</p> 	<ol style="list-style-type: none"> <li>1) When temperature of the indoor heat exchanger drops below 5°C, the compressor speed is reduced. (P zone)</li> <li>2) When temperature of the indoor heat exchanger rises in the range from 6°C to under 7°C, the compressor speed is kept. (Q zone)</li> <li>3) When temperature of the indoor heat exchanger rises to 7°C or higher, the capacity control operation returns to the usual control in cooling operation. (R zone)</li> </ol>
	<p><b>&lt;In heating operation&gt;</b>            (Prevent-overpressure control for refrigerating cycle)            In heating operation, the sensor of indoor heat exchanger detects condensation temperature and controls the compressor speed so that temperature of the heat exchanger does not exceed the specified value.</p> 	<ol style="list-style-type: none"> <li>1) When temperature of the indoor heat exchanger rises in the range from 52°C to 55°C, the compressor speed is kept. (Q zone)            When temperature of the indoor heat exchanger drops in the range from 48°C to under 55°C, the compressor speed is kept. (Q zone)</li> <li>2) When temperature of the indoor heat exchanger rises to 55°C or higher, the compressor speed is reduced. (P zone)</li> <li>3) When temperature of the indoor heat exchanger does not rise to 52°C, or when it drops below to 48°C, the capacity control operation returns to the usual control in heating operation. (R zone)</li> </ol>

Item	Operation flow and applicable data, etc.	Description
<b>7. Defrost control (Only in heating operation)</b>	(This function removes frost adhered to the outdoor heat exchanger.) The temperature sensor of the outdoor heat exchanger (Te sensor) judges the frosting status of the outdoor heat exchanger and the defrost operation is performed with 4-way valve reverse defrost system.	The necessity of defrost operation is detected by the outdoor heat exchanger temperature. The conditions to detect the necessity of defrost operation differ in A, B, or C zone each. (Table 1)

**Start of heating operation**

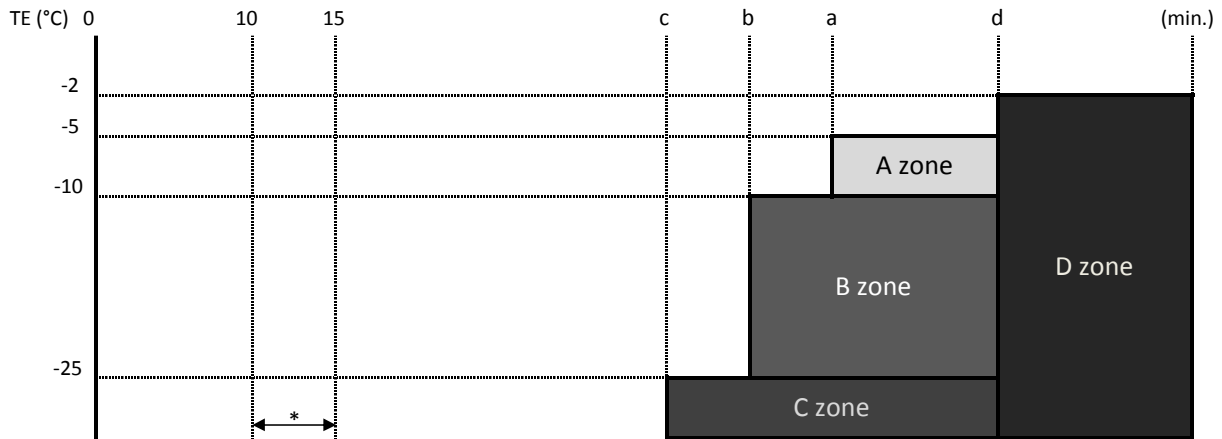

\* The minimum TE value and To value between 10 and 15 minutes after heating operation has started are stored in memory as TE0 and TO0, respectively.

**Table 1**

Defrost zone	In normal TO	In abnormal TO ***
A zone	$TO \geq -10\text{ }^\circ\text{C}$ & $(TE0-TE)-(TO0-TO) \geq 3\text{ }^\circ\text{C}$ & $SH-SH0 \leq 2$	$TE0-TE \geq 3\text{ }^\circ\text{C}$ & $SH-SH0 \leq 2$
B zone	$TO \geq -10\text{ }^\circ\text{C}$ & $(TE0-TE)-(TO0-TO) \geq 2\text{ }^\circ\text{C}$ & $SH-SH0 \leq 2$	$TE0-TE \geq 2\text{ }^\circ\text{C}$ & $SH-SH0 \leq 2$
C zone	$TO \geq -10\text{ }^\circ\text{C}$ & $TE \leq -25\text{ }^\circ\text{C}$ & $SH-SH0 \leq 2$	
D zone	$TO \geq -10\text{ }^\circ\text{C}$ & Accumulate heating operation time $\geq e$ minute & $TE < 0\text{ }^\circ\text{C}$	

**Table 2**

Heating operation (time)	Model		
	RAS-10J2FVG-TR	RAS-13J2FVG-TR	RAS-18J2FVG-TR
a	43	51	43
b	39	49	41
c	31	31	29
d	90	90	90

**<Defrost operation>**

- Defrost operation in A to C zones
- 1) Stop operation of the compressor for 40 seconds.
- 2) Invert (OFF) 4-way valve 40 seconds after stop of the compressor.
- 3) The outdoor fan stops at the same time when the compressor stops.
- 4) When temperature of the indoor heat exchanger becomes 38°C or lower, stop the indoor fan.

**<Finish of defrost operation>**

- Returning conditions from defrost operation to heating operation
- 1) Temperature of outdoor heat exchanger rises to +8°C or higher for 3 seconds.
- 2) Temperature of outdoor heat exchanger is kept at +7°C or higher for 60 seconds.
- 3) Defrost operation continues for 10 minutes.

**<Returning from defrost operation>**

- 1) Stop operation of the compressor for approx. 40 seconds.
- 2) Invert (ON) 4-way valve approx. 30 seconds after stop of the compressor.
- 3) The outdoor fan starts rotating at the same time when the compressor starts.

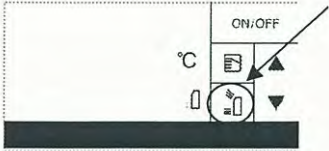
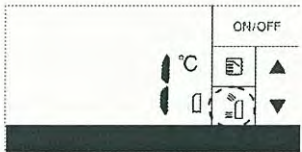

Item	Operation flow and applicable data,etc	Description																											
<b>8. Air outlet selection</b>	<p>&lt; How to change air outlet selection &gt;</p> <ol style="list-style-type: none"> <li>Operate the air conditioner and select cooling or heating mode. (Air outlet selection can't be changed at standby mode.)</li> <li>Push AIR OUTLET SELECT button on the unit operation panel to change air outlet selection.</li> </ol> <p>AIR OUTLET indication      AIR OUTLET SELECT button</p>  <p>Air outlet is controlled as below.</p> <table border="1" data-bbox="156 730 979 1400"> <thead> <tr> <th rowspan="2">AIR OUTLET indicator</th> <th colspan="4">Mode</th> </tr> <tr> <th colspan="2">Cooling</th> <th>Dry mode</th> <th colspan="2">Heating</th> </tr> </thead> <tbody> <tr> <td>Bi-flow</td> <td><math>TA &gt; T_{sc} + 1^{\circ}C</math></td> <td><math>TA \leq T_{sc} + 1^{\circ}C</math> or (<math>TA \leq T_{sc} + 1.5</math> and after 1hour running)</td> <td rowspan="2" style="text-align: center;">/</td> <td><math>TC &lt; 33^{\circ}C</math></td> <td><math>TC \geq 33^{\circ}C</math></td> </tr> <tr> <td>Upper flow</td> <td colspan="2" style="text-align: center;">/</td> <td colspan="2" style="text-align: center;">/</td> </tr> <tr> <td>Lower-flow</td> <td colspan="2" style="text-align: center;">/</td> <td colspan="2" style="text-align: center;">/</td> <td style="text-align: center;">/</td> </tr> </tbody> </table>	AIR OUTLET indicator	Mode				Cooling		Dry mode	Heating		Bi-flow	$TA > T_{sc} + 1^{\circ}C$	$TA \leq T_{sc} + 1^{\circ}C$ or ( $TA \leq T_{sc} + 1.5$ and after 1hour running)	/	$TC < 33^{\circ}C$	$TC \geq 33^{\circ}C$	Upper flow	/		/		Lower-flow	/		/		/	<ol style="list-style-type: none"> <li>Purpose</li> <li>Description</li> </ol>
AIR OUTLET indicator	Mode																												
	Cooling		Dry mode	Heating																									
Bi-flow	$TA > T_{sc} + 1^{\circ}C$	$TA \leq T_{sc} + 1^{\circ}C$ or ( $TA \leq T_{sc} + 1.5$ and after 1hour running)	/	$TC < 33^{\circ}C$	$TC \geq 33^{\circ}C$																								
Upper flow	/			/																									
Lower-flow	/		/		/																								
	<p>&lt; How to cancel to change upper-flow at Bi-flow setting in cooling &gt;</p> <ol style="list-style-type: none"> <li>Stop operation.</li> <li>Push and hold AIR OUTLET SELECT button on the unit operation panel over 10seconds (less than 20seconds).</li> </ol> <p>AIR OUTLET SELECT button</p>  <ol style="list-style-type: none"> <li>After holding 10seconds, 4 beep sounds in heard and TEMPERATURE indicator displays "1" for 5seconds. Release AIR OUTLET SELECT button.</li> </ol> 	<ul style="list-style-type: none"> <li>In Cooling operation, only lower-flow can't be selected.</li> <li>In Dry mode operation, bi-flow and lower-flow can't be selected.</li> <li>In heating operation and bi-flow setting, the air outlet is set only upper flow for preventing cold draft when the indoor heat exchanger sensor temperature (TC) is lower than 33 degrees.</li> <li>In cooling operation and bi-flow setting, the air outlet is set only upper flow for pravitning the room from overcooling when the room temperature (TA) is nearing the setup temperature. This function can be cancelled to change setting.</li> </ul>																											

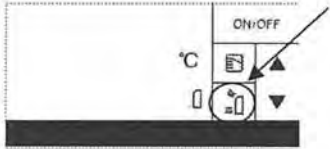
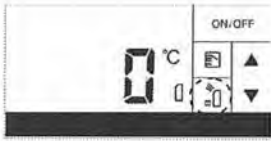
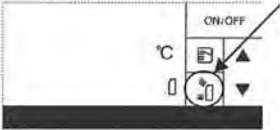
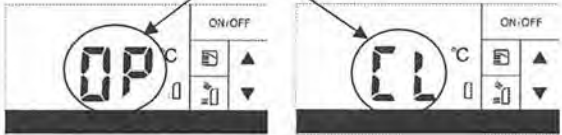
Item	Operation flow and applicable data,etc	Description															
<p><b>8. Air outlet selection</b></p>	<p>&lt; How to set to change upper-flow at Bi-flow setting in cooling</p> <ol style="list-style-type: none"> <li>1. Stop operation.</li> <li>2. Push and hold AIR OUTLET SELECT button on the unit operation panel over 10seconds (less than 20seconds).</li> </ol> <p style="text-align: center;">AIR OUTLET SELECT button</p>  <ol style="list-style-type: none"> <li>3. After holding 10seconds, 4 beep sounds in heard and TEMPERATURE indicator displays "1" for 5seconds. Release AIR OUTLET SELECT button.</li> </ol> 																
<p><b>9. Lower air outlet louver control</b></p>	<p>&lt; How to open or close the lower louver at standby mode &gt;</p> <ol style="list-style-type: none"> <li>1. Push AIR OUTLET SELECT button on the unit operation panel.</li> </ol> <p style="text-align: center;">AIR OUTLET SELECT button</p>  <ol style="list-style-type: none"> <li>2. When lower louver is closed, lower louver moves to open position and TEMPERATURE indicator displays "OP" (OPEN) during louver moving.</li> </ol> <p>When lower louver is opened, lower louver moves to open position and TEMPERATURE indicator displays "CL" (CLOSE) during louver moving.</p> <p>&lt;Close-&gt;Open&gt;                      &lt;Open-&gt;Close&gt;</p> <p style="text-align: center;">TEMPERATURE indicator</p>  <p>&lt; Louver position in operation &gt;</p> <p>Lower louver is controlled in operation as below.</p> <table border="1" data-bbox="395 1809 900 2069"> <thead> <tr> <th rowspan="2">Louver Position</th> <th colspan="3">Air outlet</th> </tr> <tr> <th>Bi-flow</th> <th>Upper-flow</th> <th>Lower-flow</th> </tr> </thead> <tbody> <tr> <td>OPEN</td> <td></td> <td></td> <td></td> </tr> <tr> <td>CLOSE</td> <td></td> <td></td> <td></td> </tr> </tbody> </table>	Louver Position	Air outlet			Bi-flow	Upper-flow	Lower-flow	OPEN				CLOSE				<ol style="list-style-type: none"> <li>1. Purpose When something is dropped to inside of the unit from upper air outlet, this function helps to remove something from lower air outlet</li> </ol>
Louver Position	Air outlet																
	Bi-flow	Upper-flow	Lower-flow														
OPEN																	
CLOSE																	

Item	Operation flow and applicable data,etc	Description												
<b>10.Upper air outlet louver control</b>	<p>Upper louver position can be arbitrarily set pu by pushing [FIX] button of the remote control.</p> <p>The position is controlled as below.</p>	<p>1. Description</p> <ul style="list-style-type: none"> <li>Upper louver position is stored in memory by the microcomputer, and the louver returns to the stored position when the next operation is performed. (Cooling/heating memory position)</li> </ul>												
<table border="1"> <thead> <tr> <th>Mode</th> <th>louver position</th> </tr> </thead> <tbody> <tr> <td>Cooling</td> <td>①→②→③→④→⑤→⑥→⑦→⑧→⑨→⑩→⑪→⑫→①.....</td> </tr> <tr> <td>Heating</td> <td>①→②→③→④→⑤→⑥→⑦→⑧→⑨→⑩→⑪→⑫→⑬→⑭→⑮→⑯→⑰→⑱→①...</td> </tr> <tr> <td>Cooling (Consealed setting)</td> <td>②→③→④→⑤→⑥→⑦→⑧→⑨→⑩→⑪→⑫→②.....</td> </tr> <tr> <td>Heating (Consealed setting)</td> <td>②→③→④→⑤→⑥→⑦→⑧→⑨→⑩→⑪→⑫→②.....</td> </tr> <tr> <td>Self cleaning</td> <td>⑱</td> </tr> </tbody> </table>			Mode	louver position	Cooling	①→②→③→④→⑤→⑥→⑦→⑧→⑨→⑩→⑪→⑫→①.....	Heating	①→②→③→④→⑤→⑥→⑦→⑧→⑨→⑩→⑪→⑫→⑬→⑭→⑮→⑯→⑰→⑱→①...	Cooling (Consealed setting)	②→③→④→⑤→⑥→⑦→⑧→⑨→⑩→⑪→⑫→②.....	Heating (Consealed setting)	②→③→④→⑤→⑥→⑦→⑧→⑨→⑩→⑪→⑫→②.....	Self cleaning	⑱
Mode	louver position													
Cooling	①→②→③→④→⑤→⑥→⑦→⑧→⑨→⑩→⑪→⑫→①.....													
Heating	①→②→③→④→⑤→⑥→⑦→⑧→⑨→⑩→⑪→⑫→⑬→⑭→⑮→⑯→⑰→⑱→①...													
Cooling (Consealed setting)	②→③→④→⑤→⑥→⑦→⑧→⑨→⑩→⑪→⑫→②.....													
Heating (Consealed setting)	②→③→④→⑤→⑥→⑦→⑧→⑨→⑩→⑪→⑫→②.....													
Self cleaning	⑱													
<p>Upper limit (Heating) ⑯ <math>\theta = 72^\circ</math></p> <p>⑰ <math>\theta = 66^\circ</math></p> <p>⑱ <math>\theta = 61^\circ</math></p> <p>Upper limit (Cooling) Cooling position Heating position ① <math>\theta = 55^\circ</math></p> <p>Upper limit (Consealed) ② <math>\theta = 49^\circ</math></p> <p>③ <math>\theta = 44^\circ</math></p> <p>Maximum Air flow volume ④ <math>\theta = 38^\circ</math></p> <p>⑤ <math>\theta = 33^\circ</math></p> <p>⑥ <math>\theta = 27^\circ</math></p> <p>⑮ <math>\theta = 69^\circ</math></p> <p>⑭ <math>\theta = 63^\circ</math></p> <p>⑬ <math>\theta = 58^\circ</math></p> <p>⑫ <math>\theta = 52^\circ</math></p> <p>⑪ <math>\theta = 47^\circ</math></p> <p>⑩ <math>\theta = 41^\circ</math></p> <p>⑨ <math>\theta = 35^\circ</math></p> <p>⑧ <math>\theta = 30^\circ</math></p> <p>⑦ <math>\theta = 24^\circ</math> Lower limit</p> <p>Self cleaning operation ⑱ <math>\theta = 134^\circ</math></p> <p>Closed position <math>\theta = 145^\circ</math></p>														



Item	Operation flow and applicable data, etc.	Description														
<b>12. Test operation</b>	<p>When keeping [OPERATION] button pressed for 10 seconds or more, the temporary [COOL] operation is performed.</p> <pre> graph TD     A{Filter lamp ON} -- YES --&gt; B[Press [OPERATION] button.]     A -- NO --&gt; C{Did you press [OPERATION] button for 3 seconds or more?}     C -- NO --&gt; D[Previous setting operation]     C -- YES --&gt; E{Did you press [OPERATION] button for 10 seconds or more?}     E -- YES --&gt; F[Test [COOL] Operation]     E -- NO --&gt; G[Switch to [AUTO RESTART] control.]     B --&gt; A     </pre>	<ol style="list-style-type: none"> <li>1) When pressing [OPERATION] button, the previous setting operation starts.</li> <li>2) When keeping [OPERATION] button pressed for 3 seconds or more, Pi, Pi, Pi sound is heard and [AUTO RESTART] control is changed.</li> <li>3) When keeping [OPERATION] button pressed for 10 seconds or more, "Pi" sound is heard and the test [COOL] operation starts.</li> <li>4) If the filter lamp goes on, press [OPERATION] button to go off the filter lamp, and then press [OPERATION] button again.</li> <li>5) To stop the test operation, press the button again.</li> </ol>														
<b>13. Discharge temperature control</b>	<table border="1"> <thead> <tr> <th data-bbox="165 920 317 958">Td value</th> <th data-bbox="322 920 919 958">Control operation</th> </tr> </thead> <tbody> <tr> <td data-bbox="236 981 317 1010">117°C</td> <td data-bbox="322 965 919 994">Judges as an error and stops the compressor.</td> </tr> <tr> <td data-bbox="236 1021 317 1050">115°C</td> <td data-bbox="322 1005 919 1034">Reduce the compressor speed.</td> </tr> <tr> <td data-bbox="236 1061 317 1090">106°C</td> <td data-bbox="322 1046 919 1075">Reduce slowly compressor speed.</td> </tr> <tr> <td data-bbox="236 1102 317 1131">103°C</td> <td data-bbox="322 1086 919 1115">Keeps the compressor speed.</td> </tr> <tr> <td data-bbox="236 1196 317 1225">96°C</td> <td data-bbox="322 1126 919 1205">If the operation is performed with lower speed than one commanded by the serial signal, speed is slowly raised up to the commanded speed.</td> </tr> <tr> <td></td> <td data-bbox="322 1211 919 1240">Operates with speed commanded by the serial signal.</td> </tr> </tbody> </table>	Td value	Control operation	117°C	Judges as an error and stops the compressor.	115°C	Reduce the compressor speed.	106°C	Reduce slowly compressor speed.	103°C	Keeps the compressor speed.	96°C	If the operation is performed with lower speed than one commanded by the serial signal, speed is slowly raised up to the commanded speed.		Operates with speed commanded by the serial signal.	<ol style="list-style-type: none"> <li><b>1. Purpose</b> This function detects error on the refrigerating cycle or error on the compressor, and performs protective control.</li> <li><b>2. Operation</b> <ul style="list-style-type: none"> <li>• Control of the compressor speed The speed control is performed as described in the left table based upon the discharge temperature.</li> </ul> </li> </ol>
Td value	Control operation															
117°C	Judges as an error and stops the compressor.															
115°C	Reduce the compressor speed.															
106°C	Reduce slowly compressor speed.															
103°C	Keeps the compressor speed.															
96°C	If the operation is performed with lower speed than one commanded by the serial signal, speed is slowly raised up to the commanded speed.															
	Operates with speed commanded by the serial signal.															
<b>14. High pressure control</b>	<table border="1"> <thead> <tr> <th data-bbox="220 1509 317 1563">Cooling (TE)</th> <th data-bbox="322 1509 919 1563">Control operation</th> </tr> </thead> <tbody> <tr> <td data-bbox="236 1574 317 1603">63°C</td> <td data-bbox="322 1568 919 1597">Judges as an error and stops the compressor.</td> </tr> <tr> <td data-bbox="236 1615 317 1644">63°C</td> <td data-bbox="322 1608 919 1637">Reduce the compressor speed.</td> </tr> <tr> <td data-bbox="236 1655 317 1684">61°C</td> <td data-bbox="322 1648 919 1677">Reduce slowly compressor speed.</td> </tr> <tr> <td data-bbox="236 1688 317 1718">59°C</td> <td data-bbox="322 1682 919 1711">Keeps the compressor speed.</td> </tr> <tr> <td data-bbox="236 1776 317 1805">55°C</td> <td data-bbox="322 1727 919 1805">If the operation is performed with lower speed than one commanded by the serial signal, speed is slowly raised up to the commanded speed.</td> </tr> <tr> <td></td> <td data-bbox="322 1812 919 1841">Operates with speed commanded by the serial signal.</td> </tr> </tbody> </table>	Cooling (TE)	Control operation	63°C	Judges as an error and stops the compressor.	63°C	Reduce the compressor speed.	61°C	Reduce slowly compressor speed.	59°C	Keeps the compressor speed.	55°C	If the operation is performed with lower speed than one commanded by the serial signal, speed is slowly raised up to the commanded speed.		Operates with speed commanded by the serial signal.	<ol style="list-style-type: none"> <li><b>1. Purpose</b> This function detects error on the refrigerating cycle or error on the compressor, and performs protective control.</li> <li><b>2. Operation</b> Control of the compressor speed The speed control is performed as described in the left table based upon the heat exchanger temperature (TE, TC).</li> </ol>
Cooling (TE)	Control operation															
63°C	Judges as an error and stops the compressor.															
63°C	Reduce the compressor speed.															
61°C	Reduce slowly compressor speed.															
59°C	Keeps the compressor speed.															
55°C	If the operation is performed with lower speed than one commanded by the serial signal, speed is slowly raised up to the commanded speed.															
	Operates with speed commanded by the serial signal.															

Item	Operation flow and applicable data, etc.	Description
<p><b>15. Pulse Modulating value (P.M.V.) control</b></p>	<p>This function controls throttle amount of the refrigerant in the refrigerating cycle. According to operating status of the air conditioner, this function also controls the open degree of valve with an expansion valve with pulse Modulation.</p> <pre> graph TD     Start[Starting up] --&gt; Init[Initialize]     Init --&gt; Move[Move to initial position]     Move --&gt; Comp[Compressor ON]     Comp --&gt; SH[*SH control]     Comp --&gt; Td[Td release control]     SH --&gt; PMV[*PMV open degree control]     Td --&gt; PMV     PMV --&gt; Stop[Stop by remote controller]     PMV --&gt; Room[Room temp. sensor (Ta sensor) control]     Stop --&gt; Power[Power OFF]     Room --&gt; Defrost[Defrost]     Defrost --&gt; Move   </pre> <p>* SH (Super Heat amount) = TS (Temperature of suction pipe of the compressor) – TC or TE (Heat exchanger temperature at evaporation side)</p> <p>* PMV: Pulse Modulating Valve</p>	<ol style="list-style-type: none"> <li>1) When starting the operation, move the valve once until it fits to the stopper. (Initialize) In this time, "Click" sound may be heard.</li> <li>2) Adjust the open degree of valve by super heat amount. (SH control)</li> <li>3) If the discharge temperature was excessively up, adjust the open degree of valve so that it is in the range of set temperature. (Discharge temp. control)</li> <li>4) When defrost operation is performed, the open degree of valve is adjusted according to each setup conditions during preparation for defrost and during defrost operation (4-way valve is inverted.).</li> <li>5) To turn off the compressor while the air conditioner stops by control of the thermostat or by remote controller, adjust the open degree of valve to the setup value before stop of the compressor.</li> </ol>

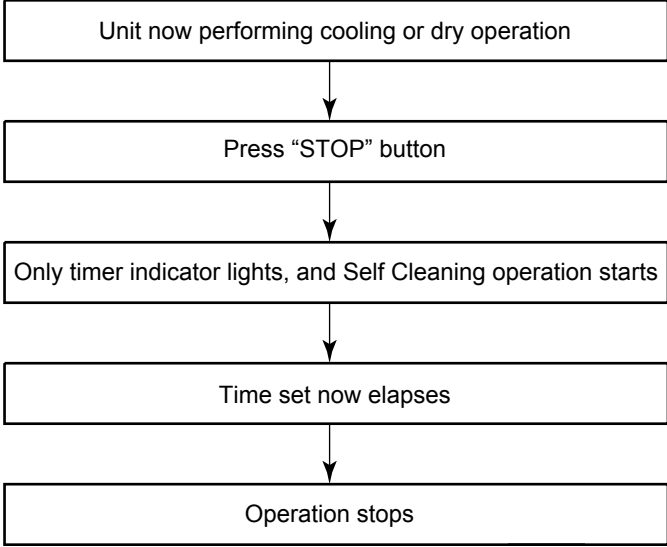
Item	Operation flow and applicable data, etc.	Description													
<p><b>16. Self-Cleaning function</b></p>	 <pre> graph TD     A[Unit now performing cooling or dry operation] --&gt; B[Press "STOP" button]     B --&gt; C[Only timer indicator lights, and Self Cleaning operation starts]     C --&gt; D[Time set now elapses]     D --&gt; E[Operation stops]           </pre> <ul style="list-style-type: none"> <li>• During Self-Cleaning operations: The louver opens slightly. The indoor fan operates continuously at a speed of 240 rpm.</li> </ul> <p>Self-Cleaning operation times</p> <table border="1" data-bbox="397 1227 1262 1576"> <thead> <tr> <th></th> <th>Operation time</th> <th>Self-Cleaning operation time</th> </tr> </thead> <tbody> <tr> <td rowspan="2">Cooling: Auto (cooling) Dry</td> <td>Up to 10 minutes</td> <td>No Self-Cleaning operation performed (0 minutes)</td> </tr> <tr> <td>10 minutes or longer</td> <td>30 mins.</td> </tr> <tr> <td>Heating: Auto (heating)</td> <td colspan="2" rowspan="3">No Self-Cleaning operation performed</td> </tr> <tr> <td>Auto (fan only)</td> </tr> <tr> <td>Shutdown</td> </tr> </tbody> </table> <ul style="list-style-type: none"> <li>• To stop an ongoing Self-Cleaning operation at any time Press the start/stop button on the remote controller twice during the Self-Cleaning operation. (After pressing the button for the first time, press it for the second time without delay (within 10 minutes).)</li> </ul>		Operation time	Self-Cleaning operation time	Cooling: Auto (cooling) Dry	Up to 10 minutes	No Self-Cleaning operation performed (0 minutes)	10 minutes or longer	30 mins.	Heating: Auto (heating)	No Self-Cleaning operation performed		Auto (fan only)	Shutdown	<p><b>1. Purpose</b></p> <p>The Self-Cleaning operation is to minimize the growth of mold, bacteria etc. by running the fan and drying so as to keep the inside of the air conditioner clean.</p> <p><b>Self-Cleaning operation</b></p> <p>When the cooling or dry operation shuts down, the unit automatically starts the Self-Cleaning operation which is then performed for the specified period based on duration of the operation which was performed prior to the shutdown, after which the Self-Cleaning operation stops. (The Self-Cleaning operation is not performed after a heating operation.)</p> <p><b>2. Operation</b></p> <ol style="list-style-type: none"> <li>1) When the stop signal from the remote controller or timer-off function is received, only the timer indicator light.</li> <li>2) The period of the Self-Cleaning operation is determined by the duration of the operation performed prior to the reception of the stop code.</li> <li>3) After the Self-Cleaning operation has been performed for the specified period, the unit stops operating.</li> </ol>
	Operation time	Self-Cleaning operation time													
Cooling: Auto (cooling) Dry	Up to 10 minutes	No Self-Cleaning operation performed (0 minutes)													
	10 minutes or longer	30 mins.													
Heating: Auto (heating)	No Self-Cleaning operation performed														
Auto (fan only)															
Shutdown															

Item	Operation flow and applicable data, etc.	Description																													
<b>16. Self-Cleaning function</b>	<ul style="list-style-type: none"> <li>Self-Cleaning diagram</li> </ul>	<table border="1" data-bbox="156 271 1433 719"> <thead> <tr> <th data-bbox="156 271 336 315">Operation display</th> <th data-bbox="336 271 775 315">ON</th> <th data-bbox="775 271 1054 315">OFF</th> <th data-bbox="1054 271 1433 315">OFF</th> </tr> </thead> <tbody> <tr> <td data-bbox="156 315 336 387">FCU fan</td> <td data-bbox="336 315 775 387">ON rpm is depend on presetting.</td> <td data-bbox="775 315 1054 387">ON (240RPM)</td> <td data-bbox="1054 315 1433 387">OFF</td> </tr> <tr> <td data-bbox="156 387 336 432">Upper airoutlet</td> <td data-bbox="336 387 775 432">OPEN</td> <td data-bbox="775 387 1054 432">OPEN (11°)</td> <td data-bbox="1054 387 1433 432">CLOSE</td> </tr> <tr> <td data-bbox="156 432 336 504">Lower airoutlet</td> <td data-bbox="336 432 775 504">OPEN or CLOSE depend on airoutlet selection</td> <td data-bbox="775 432 1054 504">OPEN or CLOSE depend on airoutlet selection</td> <td data-bbox="1054 432 1433 504">OPEN or CLOSE depend on airoutlet selection</td> </tr> <tr> <td data-bbox="156 504 336 575">Timer display</td> <td data-bbox="336 504 775 575">ON or OFF depend on presetting of timer function.</td> <td data-bbox="775 504 1054 575">ON</td> <td data-bbox="1054 504 1433 575">ON or OFF depend on presetting of timer function.</td> </tr> <tr> <td data-bbox="156 575 336 647">Compressor</td> <td data-bbox="336 575 775 647">ON or OFF depend on presetting per room temperature.</td> <td data-bbox="775 575 1054 647">OFF</td> <td data-bbox="1054 575 1433 647">OFF</td> </tr> <tr> <td data-bbox="156 647 336 719">CDU fan</td> <td data-bbox="336 647 775 719">ON or OFF depend on presetting per room temperature.</td> <td data-bbox="775 647 1054 719">OFF</td> <td data-bbox="1054 647 1433 719">OFF</td> </tr> </tbody> </table> <div data-bbox="336 719 1433 907" style="text-align: center;"> <p>Turn off by remote controller or timer-off function.      Automatically turn-off.</p> </div>		Operation display	ON	OFF	OFF	FCU fan	ON rpm is depend on presetting.	ON (240RPM)	OFF	Upper airoutlet	OPEN	OPEN (11°)	CLOSE	Lower airoutlet	OPEN or CLOSE depend on airoutlet selection	OPEN or CLOSE depend on airoutlet selection	OPEN or CLOSE depend on airoutlet selection	Timer display	ON or OFF depend on presetting of timer function.	ON	ON or OFF depend on presetting of timer function.	Compressor	ON or OFF depend on presetting per room temperature.	OFF	OFF	CDU fan	ON or OFF depend on presetting per room temperature.	OFF	OFF
Operation display	ON	OFF	OFF																												
FCU fan	ON rpm is depend on presetting.	ON (240RPM)	OFF																												
Upper airoutlet	OPEN	OPEN (11°)	CLOSE																												
Lower airoutlet	OPEN or CLOSE depend on airoutlet selection	OPEN or CLOSE depend on airoutlet selection	OPEN or CLOSE depend on airoutlet selection																												
Timer display	ON or OFF depend on presetting of timer function.	ON	ON or OFF depend on presetting of timer function.																												
Compressor	ON or OFF depend on presetting per room temperature.	OFF	OFF																												
CDU fan	ON or OFF depend on presetting per room temperature.	OFF	OFF																												
<b>17. Self-Cleaning function release</b>	<p><b>How to cancel Self-Cleaning function</b> To cancel the Self-Cleaning function, proceed as follows:</p> <p>Press and hold [MODE] button on operation panel for more than 10 seconds. (less than 20 seconds)</p> <p>After holding about 10 seconds, the air conditioner beep 4 times without any blinking of display.</p> <p>After releasing [Mode] button, Self-Cleaning function is cancelled.</p> <p><b>How to set Self-Cleaning function</b> To set the Self-Cleaning function, proceed as follows:</p> <p>Press and hold [MODE] button on operation panel for more than 10 seconds. (less than 20 seconds)</p> <p>After holding about 10 seconds, the air conditioner beep 4 times and OPERATION display blinks 5 seconds.</p> <p>After releasing [Mode] button, Self-Cleaning function is set.</p>																														

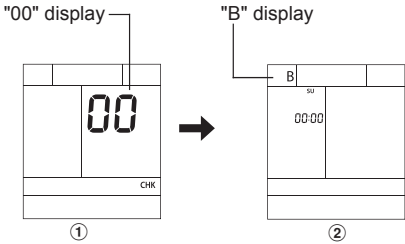

Item	Operation flow and applicable data, etc.	Description																
<p><b>18. Remote-A or B selection</b></p>	<p><b>Setting the remote controller</b></p> <p>To separate using of remote control for each indoor unit in case of 2 air conditioner are installed nearby.</p> <p><b>Remote Control B Setup.</b></p> <ol style="list-style-type: none"> <li>1) Push and hold CHECK button on the Remote Control by the tip of the pencil. "00" will be shown on the display. (Picture ①)</li> <li>2) Press [MODE] during pushing CHECK. "B" will show on the display and "00" will disappear and the air conditioner will turn OFF. The Remote Control B is memorized. (Picture ②)</li> </ol> <p>Note : 1. Repeat above step to reset Remote Control to be A. 2. Remote Control A has not "A" display. 3. Default setting of Remote Control from factory is A.</p>  <p>The diagram shows two stages of the remote control display. Stage ① shows the display with '00' and a 'CHK' button below it. Stage ② shows the display with 'B' and '00-00' below it, with an arrow indicating the transition from stage ① to stage ②.</p>	<p><b>1. Purpose</b></p> <p>This operation is to operate only one indoor unit using one remote controller.</p> <p><b>2. Description</b></p> <p>When operating one indoor unit in a situation where two indoor units have been installed in the same room or nearby rooms, this operation prevents the remote controller signal from being received simultaneously by both units, thus preventing both units from operating.</p> <p><b>3. Operation</b></p> <p>The indoor unit on which the remote controller selection has been set to B receives the signal of the remote controller also set to B. (At the factory the remote controller selection is set to A on all the indoor units. There is no A setting display.)</p>																
<p><b>19. QUIET mode</b></p>	<p>When the "Quiet mode" selected from [ FAN ] button;</p> <ul style="list-style-type: none"> <li>- The fan of the indoor unit will be restricted the revolving speed at speed UL.</li> <li>- The compressor speed is controlled as shown in the figure.</li> </ul> <table border="1" data-bbox="395 1245 919 1339"> <thead> <tr> <th>Model</th> <th>10J2FVG-TR</th> <th>13J2FVG-TR</th> <th>18J2FVG-TR</th> </tr> </thead> <tbody> <tr> <td>Cool/Heat min</td> <td>20</td> <td>20</td> <td>19</td> </tr> <tr> <td>Quiet Cool (Hz)</td> <td>44</td> <td>44</td> <td>49</td> </tr> <tr> <td>Quiet Heat (Hz)</td> <td>23</td> <td>23</td> <td>23</td> </tr> </tbody> </table> <p>When is cancel "Quiet mode". The [ FAN ] is selected other speed.</p>	Model	10J2FVG-TR	13J2FVG-TR	18J2FVG-TR	Cool/Heat min	20	20	19	Quiet Cool (Hz)	44	44	49	Quiet Heat (Hz)	23	23	23	<p>Quiet mode is the system which, control the revolving speed of indoor fan to work constantly at lower than speed L. In addition, noise level of indoor unit is less than usual.</p> <p>Remarks :</p> <ol style="list-style-type: none"> <li>1. Quiet mode is unable to work in dry mode.</li> <li>2. Quiet mode is appropriate to work with less cooling load and less heating load condition. Because of the fan speed may not enough the cooling capacity or heating capacity.</li> </ol>
Model	10J2FVG-TR	13J2FVG-TR	18J2FVG-TR															
Cool/Heat min	20	20	19															
Quiet Cool (Hz)	44	44	49															
Quiet Heat (Hz)	23	23	23															
<p><b>20. COMFORT SLEEP</b></p>	<p><b>Cooling mode</b></p> <ul style="list-style-type: none"> <li>• The preset temperature will increase as show on ECO operation (Item No. 9)</li> <li>• Press the [COMFORT SLEEP] button to choose the operating hours. Repeat pressing to select the hours. (1hr, 3hr, 5hr or 9hr)</li> <li>• If the [COMFORT SLEEP] button is pressed again means cancel comfort sleep mode.</li> </ul> <p><b>Heating mode</b></p> <ul style="list-style-type: none"> <li>• The preset temperature will drop down as show on ECO operation (Item No. 9)</li> <li>• Press the [COMFORT SLEEP] button to choose the operating hours. Repeat pressing to select thehours. (1hr, 3hr, 5hr or 9 hr)</li> <li>• If the [COMFORT SLEEP] button is pressed again means cancel comfort sleep mode.</li> </ul>	<p>The principles of comfort sleep mode are:</p> <ul style="list-style-type: none"> <li>• Quietness for more comfortable. When room temperature reach setting temperature</li> <li>• Save energy by changing room temperature automatically.</li> <li>• The air condition can shut down by itself automatically.</li> </ul> <p>Remarks:</p> <ol style="list-style-type: none"> <li>1. Comfort sleep mode will not operate in dry mode and fan only mode.</li> </ol>																

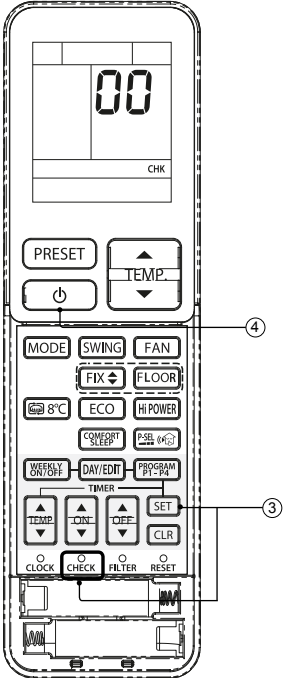
Item	Operation flow and applicable data, etc.	Description
<p><b>21. Short Timer</b></p>	<p>In the normal condition, after switching one circuit breaker, 3-minute delay time for compressor and 1 hour for plasma air purifier are set for the maintenance of the unit.</p> 	<p><b>Purpose</b> To start the unit immediately for the purpose of testing, trial...etc, short timer can be used. maintenance of the unit.</p> <p><b>Short Timer Setting</b></p> <ol style="list-style-type: none"> <li>① Press [⏻] button to turn the unit OFF.</li> <li>② Set the operation mode or plasma air purifier on the remote control without sending the signal to the unit.</li> <li>③ Use the tip of the pencil to push the [CHK] button and hold, "00" will show on display, then press [SET] button to make "00" disappear.</li> <li>④ Press [⏻] button to turn the unit ON.</li> <li>⑤ When short timer is activated, all setting on the remote operates immediately, besides, all indications on front panel turns ON continuously for 3 seconds.</li> </ol>
<p><b>22. Hi POWER Mode</b></p>	<p><b>([Hi POWER] button on the remote controller is pressed)</b></p> <p>When [Hi POWER] button is pressed while the indoor unit is in Auto, Cooling or Heating operation, Hi POWER mark is indicated on the display of the remote controller and the unit operates as follows.</p> <ol style="list-style-type: none"> <li><b>1. Automatic operation</b> <ul style="list-style-type: none"> <li>• The indoor unit operates in according to the current operation.</li> </ul> </li> <li><b>2. Cooling operation</b> <ul style="list-style-type: none"> <li>• The preset temperature drops 1°C (The value of the preset temperature on the remote controller does not change.) The indoor unit's fan speed level increase 1 tap</li> </ul> </li> <li><b>3. Heating operation</b> <ul style="list-style-type: none"> <li>• The preset temperature increases 2°C (The value of the preset temperature on the remote controller does not change.) The indoor unit's fan speed level increase 1 tap</li> </ul> </li> <li><b>4. The Hi POWER mode can not be set in Dry operation</b></li> </ol>	<p>* The Hi POWER operation will be cancelled when press [Hi POWER] button again.</p>

Item	Operation flow and applicable data,etc	Description
23. POWER Selection Mode	<p><b>([POWER-SEL] button on the remote controller is pressed)</b></p> <ul style="list-style-type: none"> <li>– Power Selection 75% is 75% of maximum current.</li> <li>– Power Selection 50% is 50% of rate maximum current.</li> </ul> <p><b>POWER-SELECTION AND SILENT OPERATION</b></p>	<p><b>1. Purpose</b></p> <p>The function is used when its circuit breaker is shared with other electrical appliances. It limits the maximum current/ power consumption to 100%, 75% or 50%. The lower the percentage, the higher the saving and also the longer the compressor lifetime.</p> <p><b>2. Description</b></p> <p>When the level is selected, Power-SEL level flashes on LCD display for 3 seconds. In case of 75% and 50% level, number "75" or "50" also flashes for 2 seconds.</p> <p>Note : Due to the reason that POWER SELECT FUNCTION limits the maximum current, inadequate capacity may occur.</p>

24. Silent Operation	<p>Silent button on remote controller is pressed.</p> <p><b>Silent 1:</b> Cooling/heating capacity is limited maximum for 70% of rated. Only compressor speed is limited.</p> <p><b>Silent 2:</b> CDU sound level is limited for lowest CDU sound level. Compressor and CDU fan speed are limited.</p>	<p>This function is used when the user need to keep silent at outdoor side. It is limit maximum compressor speed and CDU fan speed. Sound level can be implemented by 2 silent level.</p> <p><b>Sound level:</b> Rated level &gt; Silent 1 &gt; Silent 2</p> <p><b>Note:</b> Due to Silent operation reason, In adequate cooling/heating capacity may occur.</p>
----------------------	--	--

**Silent Operation description**

Models	Silent Operation	Cooling		Heating	
		Compressor frequency (rps)	CDU Fan Speed (rpm)	Compressor frequency (rps)	CDU Fan Speed (rpm)
RAS-10J2AVSG-TR	Silent 1	38	normal	53	normal
RAS-10J2AVSG-TR1	Silent 2	22	520	37	520
RAS-13J2AVSG-TR	Silent 1	54	normal	57	normal
RAS-13J2AVSG-TR1	Silent 2	28	600	38	600
RAS-18J2AVSG-TR	Silent 1	41	normal	58	normal
	Silent 2	29	600	41	600

**POWER-SELECTION AND SILENT OPERATION**

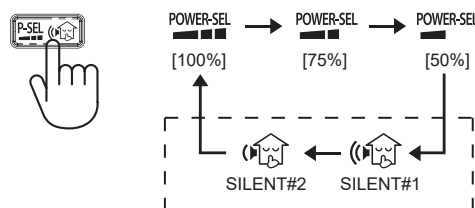

Item	Operation flow and applicable data,etc	Description
<b>25. Outdoor Quiet control</b>	<p><b>&lt;With Quiet control/Non-select method&gt;</b></p> <div style="border: 1px solid black; padding: 5px; margin-bottom: 10px;">           Select "Control" or "No control" by keeping [RESET] button pushed for 20 seconds. ("No control" at shipment from the factory.)         </div> <div style="border: 1px solid black; padding: 5px;">           Exchanging from "No control" to "Control" :            Beep sound is heard (Pi, Pi, Pi, Pi, Pi) and the operation LED 5Hz flashes for 5 seconds.             Exchanging from "Control" to "No control" :            Beep sound is heard.            (Operation LED does not flash.)         </div>	<p><b>1. Purpose</b>            For the users who concern about noise the outdoor unit, this control control the max revolutions of the compressor to reduce the noise</p> <p><b>2. Description</b>            To reduce noise, [RESET] button of the indoor unit is kept pushed for 20 seconds.            The number of revolution for the indoor fan motor and the set up temp value are kept as they are.</p> <p><b>3. Operation</b>            As show in the table, the maximum revolution number of indoor unit compressor can be reduced.            As the maximum number of revolution of the compressor is restricted, the rise-up performance at the start time is weakened.</p>

**<Maximum number of revolution of compressor at normal time and Quiet control time>**

		RAS-10J2FVG-TR		RAS-13J2FVG-TR		RAS-18J2FVG-TR	
	Outside temp. (TO)	Normal time (rps)	Quiet controlled (rps)	Normal time (rps)	Quiet controlled (rps)	Normal time (rps)	Quiet controlled (rps)
COOL		78	44	86	44	83	49
HEAT	-5°C ~	102	23	100	23	83	23
	-10 ~ -5°C ~	102	23	100	23	83	23
	-10°C ~	102	23	100	23	83	23

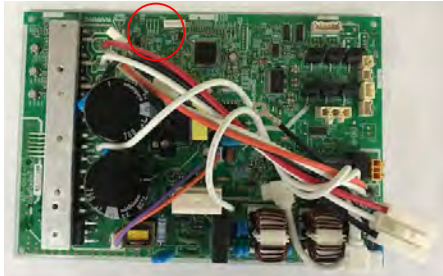
<b>26. Operation mode setectable</b>	<p>Operating system setting            For RAS-10, 13J2AVSG-TR, TR1</p>  <p>For RAS-18J2AVSG-TR</p>  <ul style="list-style-type: none"> <li>• Do cut J804 for cooling only system</li> <li>• Do cut J805 for heating only system</li> <li>• Do cut both of J804 and J805 for return to factory default.</li> </ul>	<p><b>1. Purpose</b>            Choosing the operating system as appropriate in real condition</p> <p><b>2. Operation</b>            Factory default setting prefer "Heat pump" system. Through it is able to cooling only system heating only system or return to factory default.</p>
--------------------------------------	--	---

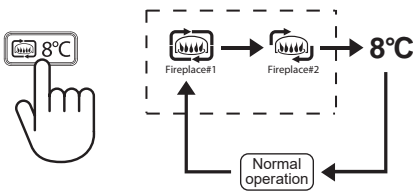
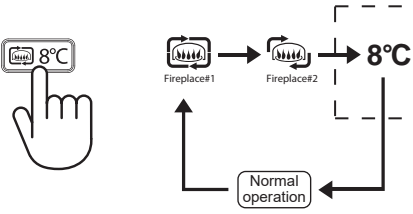
Item	Operation flow and applicable data,etc	Description
<p><b>27. Fireplace Operation</b></p>	<p>Fireplace button on remote controller is pressed.</p> <p><b>Fireplace 1:</b> Cancel cold draft prevention control and fan speed depend on user require base on basic control.</p> <p><b>Fireplace 2:</b> Cold draft prevention control is active with super low fan speed (640 rpm).</p> <p><b>Fireplace Operation</b></p> 	<p>Keep air circulation during other heat source applied.</p> <p><b>Note:</b> With Fireplace operation on heating mode indoor unit always runs and cold air breezing might be occurred.</p>
<p><b>28. 8°C heating / Frost protective operation</b></p>	<p>8°C Button on remote controller is pressed. Set temperature is performed for 5°C to 13°C and no cold draft prevention control.</p> <p><b>8°C heating operation</b></p> 	<p>Intended for cold latitudes and performs objective heating operation.</p>

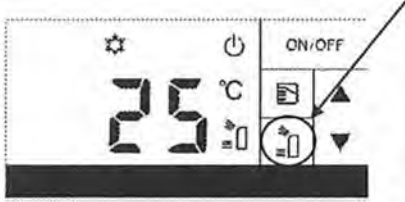
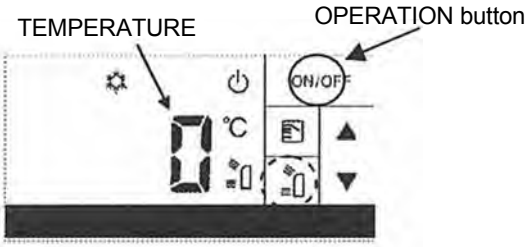
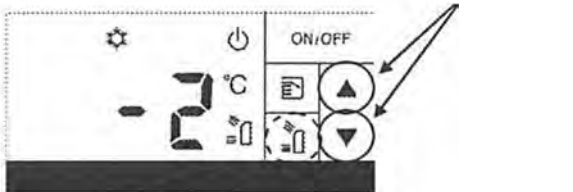
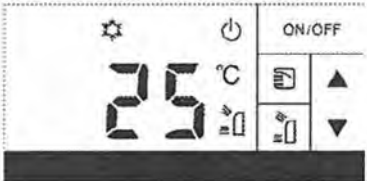
Item	Operation flow and applicable data,etc	Description						
<p><b>29. Set temp. correction</b></p>	<p>Set temp. can be corrected by changing the set temp. correction value.  Initial setting of the set temp. correction value is 0.</p> <p>Set temp. = Set temp. (TS)+ Set temp. correction  Set temp. (TS) : remote control or indoor unit display setting</p> <table border="1" data-bbox="359 392 890 537"> <thead> <tr> <th colspan="2">Set temp. correction</th> </tr> </thead> <tbody> <tr> <td>Cooling (Dry mode)</td> <td>-5 ~ +5°C</td> </tr> <tr> <td>Heating</td> <td>-5 ~ +5°C</td> </tr> </tbody> </table> <p>&lt; How to change the set temp. correction &gt;</p> <ol style="list-style-type: none"> <li>Operate the air conditioner and select cooling or heating mode. (The set temp. correction can't be changed at standby mode.)</li> <li>Push and hold AIR OUTLET SELECT button on the unit operation panel</li> </ol> <p style="text-align: center;">AIR OUTLET SELECT button</p>  <ol style="list-style-type: none"> <li>Push OPERATION button on the unit operation panel 10 times. Set temp. correction value is displayed on the TEMPERATURE indicator.</li> </ol> <p style="text-align: center;">TEMPERATURE      OPERATION button</p>  <ol style="list-style-type: none"> <li>Push TEMPERATURE button (UP or DOWN) to change set temp. correction.</li> </ol> <p style="text-align: center;">TEMPERATURE button</p>  <ol style="list-style-type: none"> <li>Release AIR OUTLET SELECT button. Set temp. correction is memorized and set temp. value is displayed on the TEMPERATURE indicator again.</li> </ol> 	Set temp. correction		Cooling (Dry mode)	-5 ~ +5°C	Heating	-5 ~ +5°C	<ol style="list-style-type: none"> <li>Purpose When the difference between the set temperature of the remote control and the room temperature is wide due to the installation condition, etc, the set temperature can be corrected.</li> <li>Description For example, when set temp. is 25°C but room temp. is stable 27°C at cooling mode, change set temp. correction (Cooling) from 0 to -2°C</li> </ol> <ul style="list-style-type: none"> <li>Continue to push and hold AIR OUTLET SELECT button.</li> <li>Continue to push and hold AIR OUTLET SELECT button.</li> </ul>
Set temp. correction								
Cooling (Dry mode)	-5 ~ +5°C							
Heating	-5 ~ +5°C							

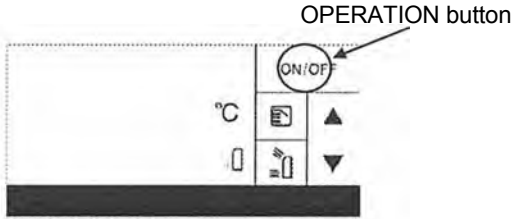
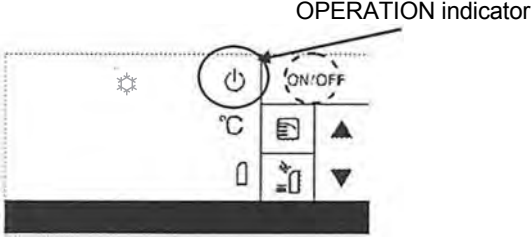
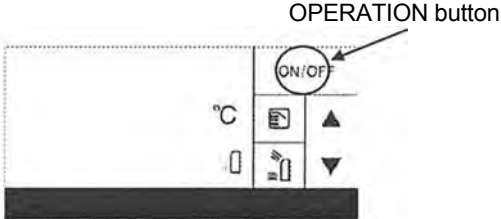
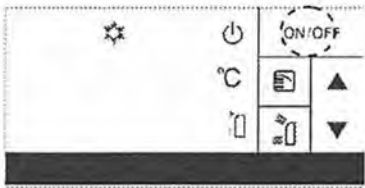
Item	Operation flow and applicable data,etc	Description																
<p><b>30. Outdoor Quiet control</b></p> <p><b>(for only 1:1 outdoor unit)</b></p>	<p>As shown in the table, the max. revolution number of compressor can be reduced.</p> <p>As the max. number of revolution of compressor is restricted, the rise-up performance at the start time is weakened.</p> <p>This function is disable with multi-outdoor unit connecting.</p> <table border="1" data-bbox="341 383 981 528"> <thead> <tr> <th>MODE</th> <th>10J2FVG-TR</th> <th>13J2FVG-TR</th> <th>18J2FVG-TR</th> </tr> <tr> <td></td> <td>Normal (rps)</td> <td>Normal (rps)</td> <td>Normal (rps)</td> </tr> </thead> <tbody> <tr> <td>Cooling</td> <td>61</td> <td>82</td> <td>80</td> </tr> <tr> <td>Heating</td> <td>85</td> <td>94</td> <td>83</td> </tr> </tbody> </table> <p>* Refer to CDU service manual combined).</p> <p>When air conditioner is on standby before setting.</p> <p>&lt; How to set Outdoor Quiet control &gt;</p> <ol style="list-style-type: none"> <li>1. Push and hold OPERATION button for 20seconds.</li> </ol>  <ol style="list-style-type: none"> <li>2. After holding 20seconds, beep sounds is heard and OPERATION indicator flashes for 5seconds. Release OPERATION button.</li> </ol>  <ol style="list-style-type: none"> <li>3. Push OPERATION button to stop temporary operation. (Set Auto restart function again)</li> </ol> <p>&lt; How to cancel Outdoor Quiet control &gt;</p> <ol style="list-style-type: none"> <li>1. Push and hold OPERATION button for 20seconds.</li> </ol>  <ol style="list-style-type: none"> <li>2. After holding 20seconds, beep sounds is heard. (OPERATION indicator doesn't flash). Release OPERATION button.</li> </ol>  <ol style="list-style-type: none"> <li>3. Push OPERATION button to stop temporary operation. (Set Auto restart function again)</li> </ol>	MODE	10J2FVG-TR	13J2FVG-TR	18J2FVG-TR		Normal (rps)	Normal (rps)	Normal (rps)	Cooling	61	82	80	Heating	85	94	83	<ol style="list-style-type: none"> <li>1. Purpose <ul style="list-style-type: none"> <li>For the users who concern about noise of the outdoor unit, this control controls the max. revolution number of the compressor to reduce the noise.</li> </ul> </li> <li>2. Description <ul style="list-style-type: none"> <li>• It can be change setting whether air conditioner is operating or not.</li> <li>• After pushing OPERATION button, air conditioner starts operation.</li> <li>• After 3seconds, 3 beeps are heard. (Auto restart setting is changed.)</li> <li>• After 10seconds, a beep is heard. (Temporary operation starts and Auto restart function is cancelled.)</li> <li>• After pushing OPERATION button, air conditioner starts operation.</li> <li>• After 3seconds, 3 beeps are heard. (Auto restart setting is changed.)</li> <li>• After 10seconds, a beep is heard. (Temporary operation starts and Auto restart function is cancelled.)</li> </ul> </li> </ol>
MODE	10J2FVG-TR	13J2FVG-TR	18J2FVG-TR															
	Normal (rps)	Normal (rps)	Normal (rps)															
Cooling	61	82	80															
Heating	85	94	83															

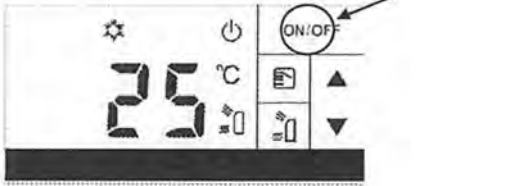
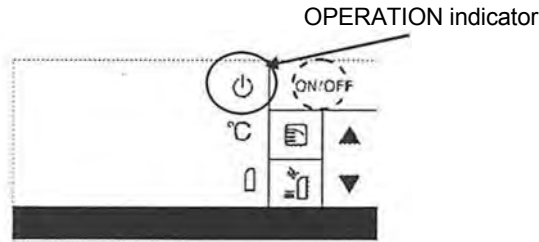
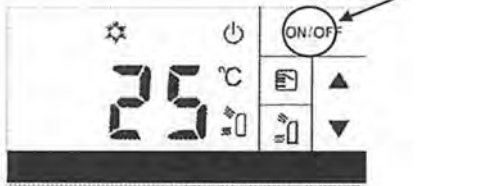
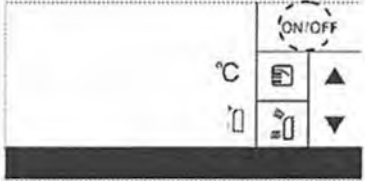
Item	Operation flow and applicable data,etc	Description
<p><b>30. Outdoor Quiet control</b> (for only 1:1 outdoor unit)</p>	<p>When air conditioner is in operation before setting.</p> <p>&lt; How to set Outdoor Quiet control &gt;</p> <p>1. Push and hold OPERATION button for 20seconds.</p>  <p>2. After holding 20seconds, beep sounds is heard and OPERATION indicator flashes for 5seconds. Release OPERATION button.</p>  <p>&lt; How to cancel Outdoor Quiet control &gt;</p> <p>1. Push and hold OPERATION button for 20seconds.</p>  <p>2. After holding 20seconds, beep sounds is heard. (OPERATION indicator doesn't flash). Release OPERATION button.</p> 	<ul style="list-style-type: none"> <li>• After pushing OPERATION button, air conditioner stops operation.</li> <li>• After 3seconds, 3 beeps are heard. (Auto restart setting is changed.)</li> </ul> <ul style="list-style-type: none"> <li>• After pushing OPERATION button, air conditioner starts operation.</li> <li>• After 3seconds, 3 beeps are heard. (Auto restart setting is changed.)</li> </ul>



### 9-3. Auto Restart Function

This indoor unit is equipped with an automatic restarting function which allows the unit to restart operating with the set operating conditions in the event of a power supply being accidentally shut down.

The operation will resume without warning three minutes after power is restored.

This function is not set to work when shipped from the factory. Therefore it is necessary to set it to work.

#### 9-3-1. How to Set the Auto Restart Function

To set the auto restart function, proceed as follows:

The power supply to the unit must be on ; the function will not set if the power is off.

Press the [OPERATION] button located in the display of the indoor unit continuously for three seconds.

The unit receives the signal and beeps three times.

The unit then restarts operating automatically in the event of power supply being accidentally shut down.

#### • When the unit is standby (Not operating)

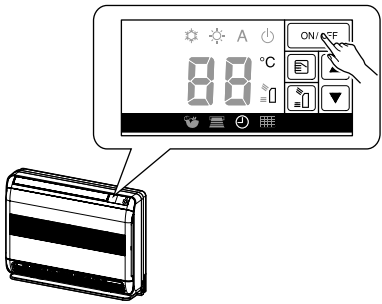
Operation	Motions
<p>Press [OPERATION] button for more than three seconds. (Less than 10 seconds)</p> 	<p>The unit is on standby.</p> <p>↓</p> <p>The unit starts to operate.                      The operation indicator is on.</p> <p>↓                      After approx. three seconds,</p> <p>The unit beeps three times and continues to operate.                      <b>The operation indicator flashes for 5 seconds.</b></p> <p>If the unit is not required to operate at this time, press [OPERATION] button once more or use the remote control to turn it off.</p>

#### • When the unit is in operation

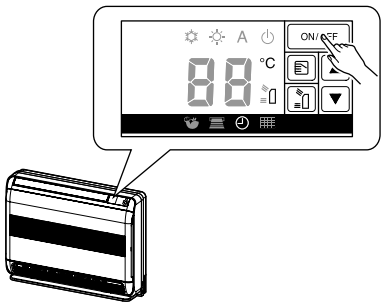
Operation	Motions
<p>Press [OPERATION] button for more than three seconds. (Less than 10 seconds)</p> 	<p>The unit is in operation.                      The operation indicator is on.</p> <p>↓</p> <p>The unit stops operating.                      The operation indicator is turned off.</p> <p>↓                      After approx. three seconds,</p> <p>The unit beeps three times.                      <b>The operation indicator flashes for 5 seconds.</b></p> <p>If the unit is required to operate at this time, press [OPERATION] button once more or use the remote control to turn it on.</p>

• While the filter check indicator is on, OPERATION button has the function of filter reset button.

### 9-3-2. How to Cancel the Auto Restart Function

To cancel auto restart function, proceed as follows :

Repeat the setting procedure : the unit receives the signal and beeps three times.

The unit will be required to be turned on with the remote control after the main power supply is turned off.

#### • When the system is on stand-by (not operating)

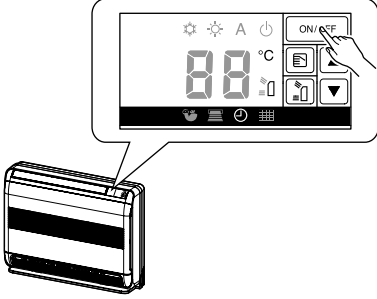
Operation	Motions
<p>Press [OPERATION] button for more than three seconds. (Less than 10 seconds)</p> 	<p>The unit is on standby.</p> <p>↓</p> <p>The unit starts to operate.                      The operation indicator is on.</p> <p>↓                      After approx. three seconds,</p> <p>The unit beeps three times and continues to operate.</p> <p>If the unit is not required to operate at this time, press [OPERATION] button once more or use the remote control to turn it off.</p>

#### • When the system is operating

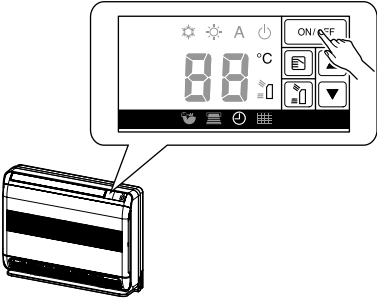
Operation	Motions
<p>Press [OPERATION] button for more than three seconds. (Less than 10 seconds)</p> 	<p>The unit is in operation.                      The operation indicator is on.</p> <p>↓</p> <p>The unit stops operating.                      The operation indicator is turned off.</p> <p>↓                      After approx. three seconds,</p> <p>The unit beeps three times.</p> <p>If the unit is required to operate at this time, press [OPERATION] button once more or use the remote control to turn it on.</p>

### 9-3-3. Power Failure During Timer Operation

When the unit is turned off because of power failure during timer operation, the timer operation is cancelled. In that case, set the timer operation again.

#### NOTE :

The Everyday Timer is reset while a command signal can be received from the remote control even if it stopped due to a power failure.

## 9-4. Remote Controller and Its Functions

### 9-4-1. Parts Name of Remote Controller

- ① Infrared signal emitter
- ② Memory and preset button ( PRESET )
- ③ Start/Stop button ( ⏻ )
- ④ Temperature up/down button ( TEMP. )
- ⑤ Mode select button ( MODE )
- ⑥ Swing louver button ( SWING )
- ⑦ Fan speed button ( FAN )
- ⑧ FLOOR button ( FLOOR )
- ⑨ 8 degree Celsius operation and Fireplace function button ( 8°C )
- ⑩ Economy button ( ECO )
- ⑪ High power button ( HI POWER )
- ⑫ Comfort sleep button ( COMFORT SLEEP )
- ⑬ Power selection and Silent operation button ( P-SEL )
- ⑭ On timer button ( ON )
- ⑮ Off timer button ( OFF )
- ⑯ Setup button ( SET )
- ⑰ Clear button ( CLR )
- ⑱ Clock setup button ( CLOCK )
- ⑲ Check button ( CHECK )
- ⑳ Filter reset button ( FILTER )
- ㉑ Reset button ( RESET )
- ㉒ Weekly ON/OFF button ( WEEKLY ON/OFF )
- ㉓ Day/Edit button ( DAY/EDIT )
- ㉔ Temp for weekly timer button ( TEMP )
- ㉕ Program P1-P4 button ( PROGRAM P1-P4 )
- ㉖ Set louver button ( FIX )

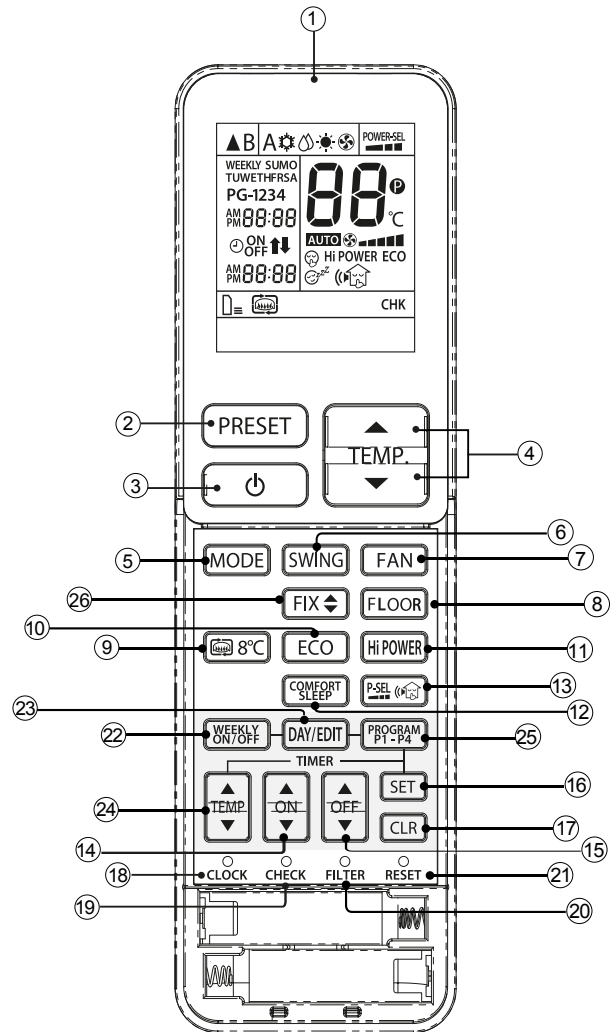

### 9-4-2. Operation of remote control

#### 1. Weekly timer operation

4 programs for each day in the week can be set in WEEKLY TIMER.

The following items can be set in WEEKLY TIMER operation.

- a. Operation time (ON timer for Start and OFF timer for Stop operation)
- b. Operation mode (AUTO, COOL, DRY, HEAT, FAN ONLY)
- c. Temperature setting.
- d. Fan speed setting.
- e. Special operation (8°C, ECO, Hi-POWER, SILENT CDU, FLOOR)

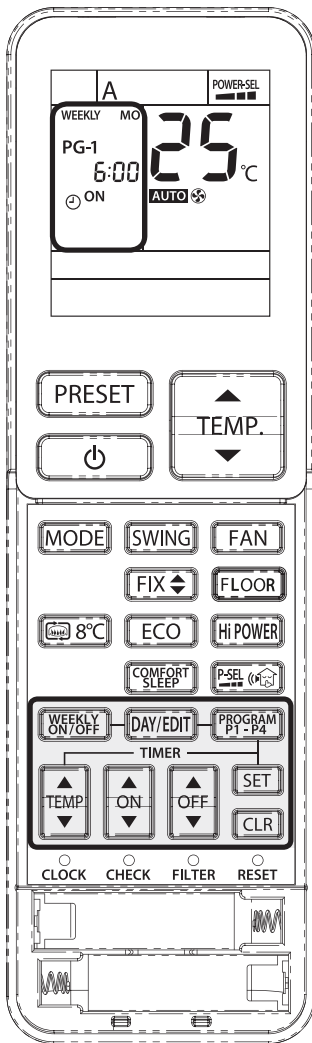

## How to set WEEKLY TIMER

**1** Press **DAY/EDIT** to enter WEEKLY TIMER setting.

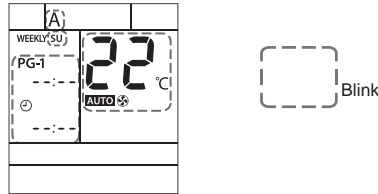

**2** Press **DAY/EDIT** to select desired day in sequence.

The sequence of day symbol appears on the LCD

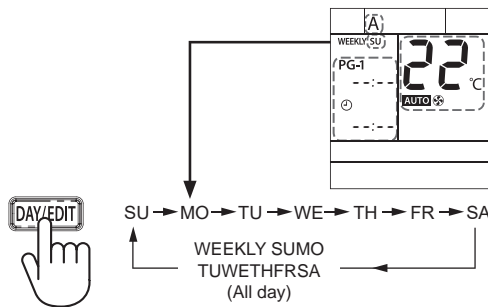

**3** Press **PROGRAM P1-P4** to select the program number.

- The program 1 is ready for setting while **DAY/EDIT** is pressed PG-1 appears on the LCD.
- Press **PROGRAM P1-P4** to change the program number in the sequence program 1 to program 4.

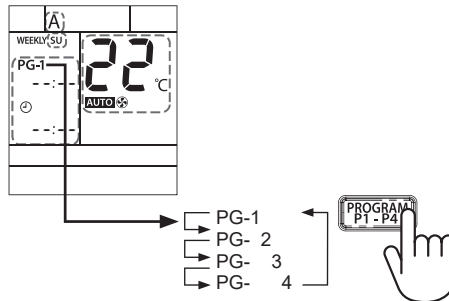

**4** Press **ON** or **OFF** to select the desired time.

- The time can be set between 0:00 and 23:50 in 10 minute intervals.
- Press and hold the button to change setting time for 1 hr.
- Only one of ON or OFF timer can be set on each program.

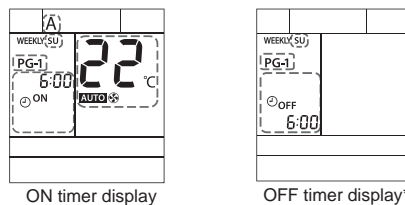

\* OFF timer is used to stop the air conditioner only. The display does not show Operation mode, Temperature, Fan speed and others.

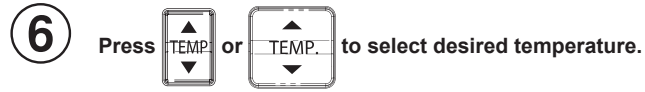
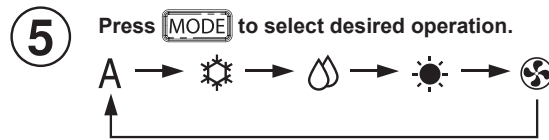

- The temperature can be set between 17°C and 30°C.

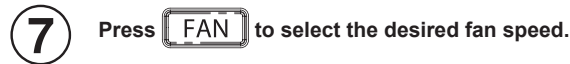

- Press **8°C** to use 8°C operation. (Notes: Fireplace cannot select and memorize in weekly function)
- Press **ECO** to use ECO operation
- Press **Hi POWER** to use Hi-POWER operation.
- Press **PSEL** to use SILENT CDU
- Press **FLOOR** to use FLOOR

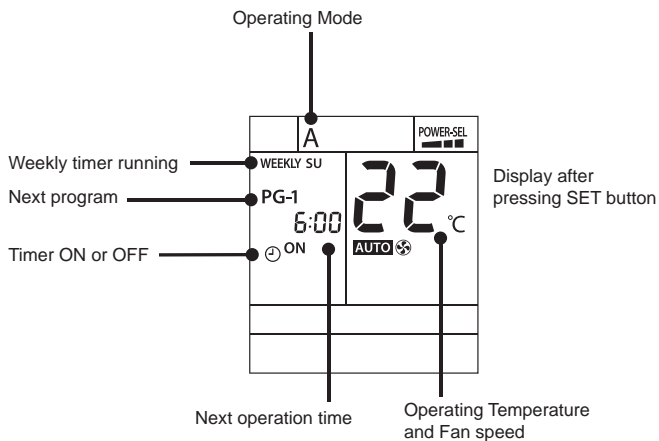
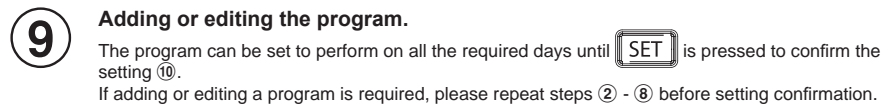

\*Point remote control at air conditioner receiving module then, press SET button until you hear the "PiPi" sound. This means the setting operation has been completed. As the air conditioner is receiving the signal, you will hear separate "Pi" sounds corresponding to the number of days in the selected setting. An incomplete setting is indicated if the TIMER lamp is blinking. Press **WEEKLY ON/OFF** twice.

### Notes

1. Place the remote control where the indoor unit can receive the signal. This will increase the accuracy of the timing between the remote control and the air conditioning unit.
2. The ON/OFF timer can be set during the WEEKLY TIMER operation. In this situation, the air conditioner will first follow the normal timer until it is complete; then, it will return to the WEEKLY TIMER function.
3. During WEEKLY TIMER operation, all of operation such as MODE, TEMP, FAN, Hi-POWER, ECO and etc., can be adjusted but when the clock reaches the program setting, the operation will return to the set items in the program.
4. When the remote control is sending a signal to the air conditioner, avoid interference from objects that can block the signal.

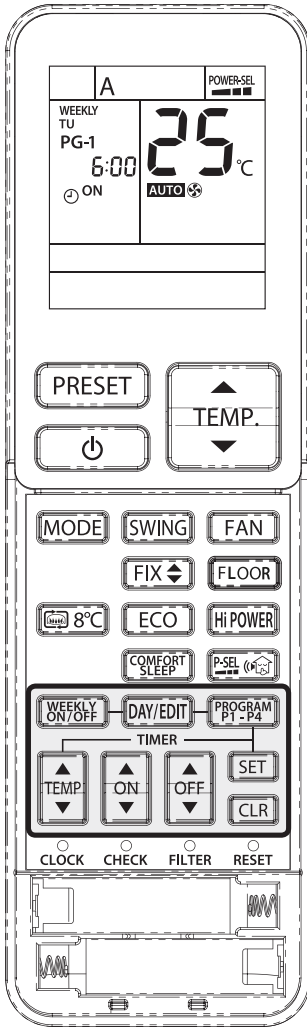

## Edit Weekly timer program

To edit the program after confirming the weekly timer setting on Page 60, follow steps ① - ③ below.

- ① Press .
  - The day of the week and the program number of the current day will be displayed.

---

- ② Press to select the day of the week and press to select program number to be confirmed.
  - Resetting the operation.

---

- ③ Press to exit confirming mode.

## Deactivating WEEKLY TIMER operation

Press while "WEEKLY" is displayed on the LCD.

- The "WEEKLY" indicator will disappear from the LCD. However, the program will remain in the remote control.
- The TIMER lamp goes off.
- To reactivate the WEEKLY TIMER operation again, press again, LCD shows the next program. The program, after reactivation, is related to the clock time.

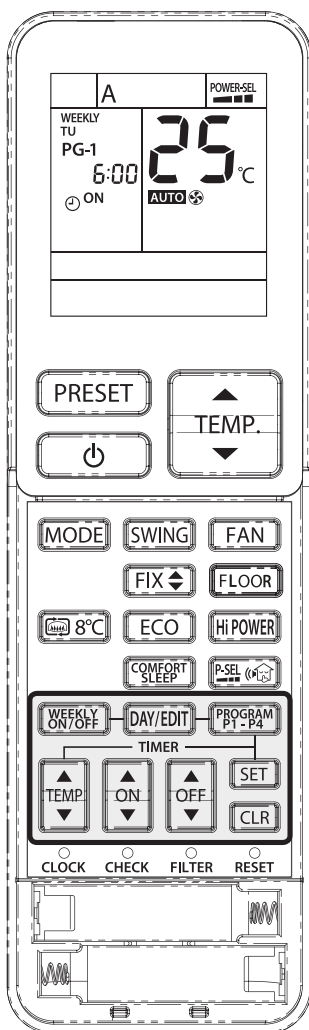

## To delete programs

### The individual program

- 1** Press **DAY/EDIT**.
  - The day of the week and the program number is displayed.
  - Select the day to delete the program.

---

- 2** Press **PROGRAM P1-P4** to select the program number to be deleted.

---

- 3** Press **CLR**.
  - ON or OFF timer will be cleared and the LCD will blink.

---

- 4** Press **SET** to delete the program.
  - Press **SET** while the LCD is blinking. The program has now been deleted.

### All programs

- 1** Press **DAY/EDIT**.
  - The day of the week and the program number will be displayed.

---





- 2** Press **CLR** and hold for 3 seconds.
  - All programs will be deleted and LCD displays current operation.

**Notes**

Make sure the remote control receiving module on the air conditioner receives the signal from the remote control.



## 2. AUTOMATIC OPERATION

To automatically select cooling, heating, or fan only operation.

1. Press  : Select Auto A.
2. Press  : Select the desired temperature : Min 17°C, Max 30°C
3. Press  : Select AUTO, LOW -, LOW+ - , MED - , MED+ - , HIGH - or Quiet 

**Note** : QUIET is ultra low fan speed for quiet operation.

## 3. 8°C OPERATION

1. Press  button to change Fireplace1, Fireplace2 and 8°C operation
2. Press  to adjust setting temperature from 5°C to 13°C





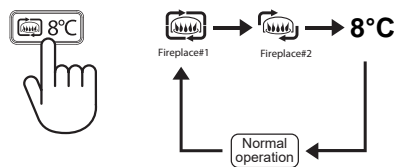

**Note1** : 8°C will operate in Heating mode only. If Air conditioner performs in cooling operation (including automatic cooling) or dry operation it will change to heating operation.

**Note2** : With Fireplace operation on heating mode indoor unit always runs and cold air breezing might be occurred.

### FIREPLACE and 8°C operation.





## 4. COOLING / HEATING / FAN ONLY OPERATION

1. Press  : Select Cool , Heat , or Fan only 
2. Press  : Set the desired temperature : Min 17°C, Max 30°C  
Fan Only : No temperature indication
3. Press  : Select AUTO, LOW -, LOW+ - , MED - , MED+ - , HIGH - or Quiet 

## 5. DRY OPERATION (COOLING ONLY)

For dehumidification, a moderate cooling performance is controlled automatically.

1. Press  : Select Dry 
2. Press  : Set the desired temperature.

**Note**: DRY mode fan speed is set to Auto only.

## 6. Hi-POWER OPERATION

To automatically control room temperature and airflow for faster cooling or heating operation (except in DRY and FAN ONLY mode)

Press  : Start and stop the operation

## 7. ECO OPERATION

To automatically control room temperature to save energy (except in DRY and FAN ONLY mode)

Press  : Start and stop the operation.

**Note**: Cooling operation; the set temperature will increase automatically 1 degree/ hour for 2 hours (maximum 2 degrees increase). For heating operation the set temperature will decrease.



## 8. AIR VOLUME, AIR DIRECTION AND SWING LOUVERS

- Changing the air volume, press FAN button

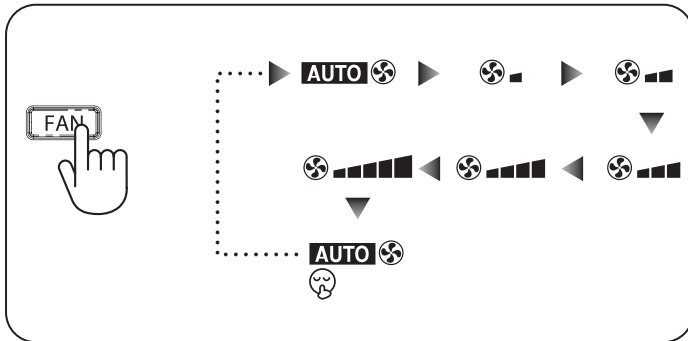

- Changing the air direction, press FIX button

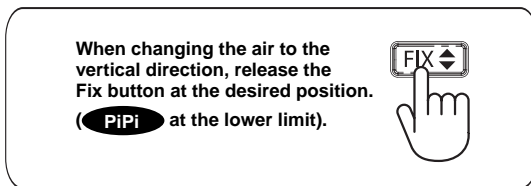

- Changing the air direction, press FIX button

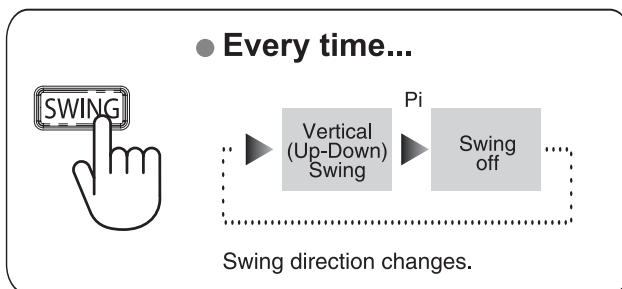

## 9. TIMER OPERATION



	Setting the ON Timer	Setting the OFF Timer
1	Press <b>ON</b> for enter ON timer setting	Press <b>OFF</b> for enter OFF timer setting
2	Press <b>ON</b> for select desired ON timer.	Press <b>OFF</b> for select desired OFF timer.
3	Press <b>SET</b> for set timer.	Press <b>SET</b> for set timer.
4	Press <b>CLR</b> for cancel timer.	Press <b>CLR</b> for cancel timer.

### Note:

- Keep the remote control in accessible transmission to the indoor unit otherwise, the time lag of up to 15 minutes will occur.
- The setting will be saved for the next same operation

## 10. PRESET OPERATION

Set your preferred operation for future use. The setting will be memorized by the unit for future operation (except air flow direction).

1. Select your preferred operation.
2. Press and hold  for 3 seconds to memorize the setting. The  mark displays.
3. Press  : Operate the preset operation.

## 11. QUIET OPERATION

To operate at ultra low fan speed for quiet operation (except in DRY mode)

Press [  ] Button : Start and stop the operation.

**Note:** Under certain conditions, QUIET operation may not provide adequate cooling or heating due to low sound features.

## 12. POWER-SELECTION OPERATION / SILENT OPERATION

Press  button to select Power-SEL, Silent 1 and Silent 2

### POWER-SELECTION AND SILENT OPERATION

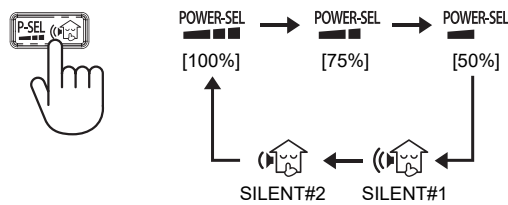

**Note1 :** When the level is selected, POWER-SEL level flashes on remote LCD display for 3 seconds  
In case of 75% and 50% level, number “75” or “50” also flashes for 2 seconds.

**Note2 :** Due to the reason that POWER SELECTION FUNCTION and silent operation, inadequate cooling or heating capacity may occur.

## 13. COMFORT SLEEP OPERATION

To save energy while sleeping, automatically control air flow and automatically turn OFF.

Press  : Select 1, 3, 5 or 9 hrs for OFF timer operation.

**Note:** The cooling operation, the set temperature will increase automatically 1 degree/hour for 2 hours (maximum 2 degrees increase). For heating operation, the set temperature will decrease.

## 14. FLOOR WARMING OPERATION

Heating will operate with downward blowing only. Temperature of air outlet will be higher than usual.

Press  : Start and stop the operation.

**Note:** FLOOR operation can active in Heat mode only.

### 9-4-3. Name and Functions of Indications on Remote Controller





#### [Display]

All indications, except for the clock time indicator, are displayed by pressing the  button.

#### 1 Transmission mark

This transmission mark  indicates when the remote controller transmits signals to the indoor unit.







#### 2 Mode indicator

Indicates the current operation mode.  
(A : Auto ,  : Cool ,  : Dry ,  : Heat ,  
 : FAN ONLY)

#### 3 Temperature indicator

Indicates the temperature setting.  
(17°C to 30°C)

#### 4 FAN speed indicator

Indicates the selected fan speed.  
AUTO, Quiet or five fan speed levels  
(LOW  , LOW+  , MED  , MED+  ,  
HIGH  , QUIET .)

Note :  Dry Mode fan speed is set to Auto only.

#### 5 TIMER and weekly timer indicator

The time setting for timer operation and weekly timer function is indicated.  
The current time is always indicated except during TIMER operation.

#### 6 Hi-POWER indicator

Indicates when the Hi-POWER operation starts.  
Press the Hi-POWER button to start and press it again to stop the operation.



#### 7 (PRESET) indicator

Flashes for 3 seconds when the PRESET button is pressed during operation.

The  mark is shown when holding down the button for more than 3 seconds while the mark is flashing.

Press another button to turn off the mark.

#### 8 POWER-SEL

Indicates the selected POWER-SEL level.  
( 100% ,  75% ,  50%)

#### 9 A, B change indicator remote controller

When the remote controller switching function is set, "B" appears in the remote controller display.  
(When the remote controller setting is "A", there is no indication at this position.)

#### 10 Comfort sleep

Indicates when comfort sleep is activated.  
Press comfort sleep button to select function.

#### 11 ECO indicator

Indicates when the ECO is in activated.  
Press the ECO button to start and press it again to stop operation.

#### 12 SILENT operation

Indicates the selected Silent 1 and Silent 2.

#### 13 FIREPLACE operation

Indicates the selected Fireplace 1 and Fireplace 2.

#### 14 FLOOR WARMING operation

Heating will operate with downward blowing only.  
Temperature of air outlet will be higher than usual.

#### 15 Service Mode indicator

Shows during enter service Mode.

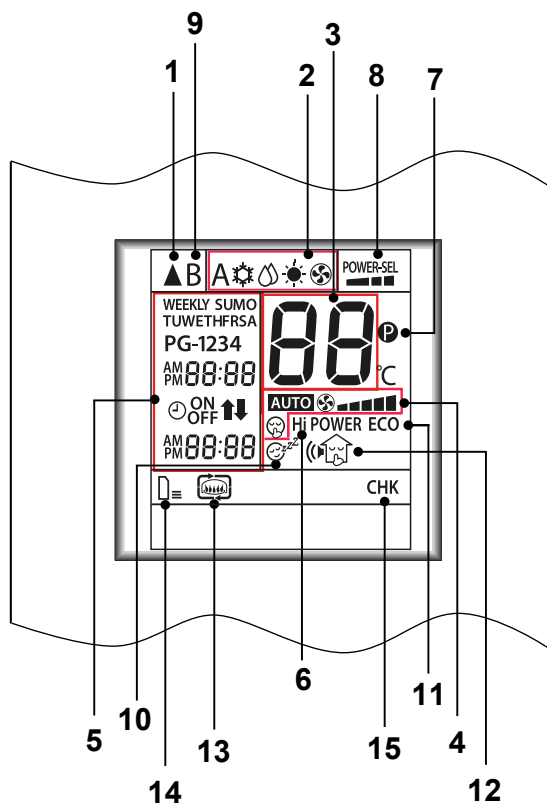

## 9-5. Indoor Unit Display & Unit Operation Panel

This indoor unit can be operated with the unit operation panel or using remote control.

Operational contents will be followed the one which was operated later.

If change the set temperature with operation panel of unit, temperature indication will be changed, but the temperature display on the remote control will not change.

If set the air flow only with the upper port, a little air flow may happen at the lower port.

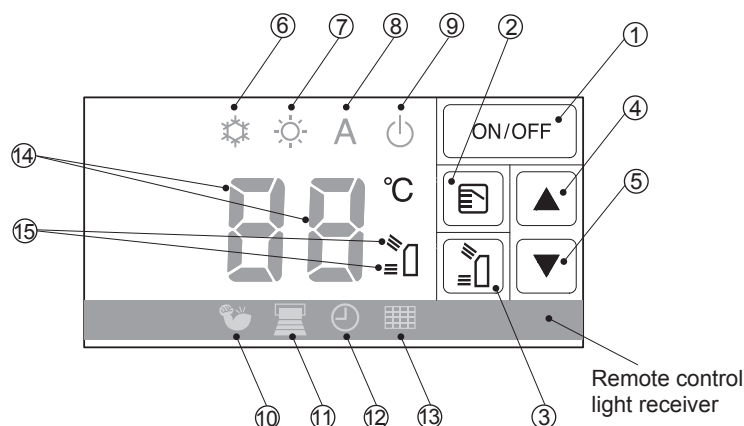

- ① OPERATION button : Unit operation ON/OFF button, turn off FILTER CHECK indicator.
- ② MODE button : Operation mode (Auto→Cooling→Heating→Auto→•••)
- \* CHILD LOCK function : Press MODE button for 3 seconds. (It is possible to operate even when stopping.)  
To cancel CHILD LOCK function, press MODE button for 3 seconds once again.  
When CHILD LOCK function is activated, 3 beeps will sound.  
When press MODE button to cancel the function, a beep will sound and then 3 seconds later 3 beep sound may occur.  
The indicator button will be invalid while the child lock function is activated.  
(When press the button, 1 beep will sound).  
Operation with remote control during the CHILD LOCK function works.  
This function is cancelled when the power supply is off or failure.
- ③ AIR OUTLET SELECT button : Cooling, Auto (Upper & Lower→Upper→Upper & Lower→•••)  
Dry (upper only)  
Heating (Upper & Lower→Upper→Upper & Lower→•••)  
On cooling operation, whichever air outlet is set, only Upper is used when the room temperature approaches the set temperature.  
During stop operation : Open/Close the lower air outlet grille.  
When the TEMPERATURE indicator display "CL" the lower air outlet grille will be in closed status.  
When the TEMPERATURE indicator display "OP" the lower air outlet grille will be in open status.
- ④ TEMPERATURE button (Up) : Setting temperature increase by 1°C (17°C→18°C••• 30°C)
- ⑤ TEMPERATURE button (Down) : Setting temperature decrease by 1°C (30°C→ 29°C••• 17°C)
- ⑥ COOL and DRY indicator (Blue)
- ⑦ HEAT indicator (Orange)
- ⑥⑦ Auto indicator (Blue) (Orange)
- ⑧ Refrigerant leak detection sensor (Green)  
\* Require connecting refrigerant leak detection sensor which available as accessory.  
Please inquire the dealership.
- ⑨ OPERATION or FAN ONLY indicator (Green)
- ⑩ HI-POWER indicator (Green)
- ⑪ FLOOR indicator (Orange)
- ⑫ TIMER indicator (Yellow)
- ⑬ FILTER CHECK indicator (Red)
- ⑭ TEMPERATURE indicator (Blue)
- ⑮ AIR OUTLET indicator (Green)

# 10. INSTALLATION PROCEDURE

## 10-1. Installation Diagram of Indoor and Outdoor Units

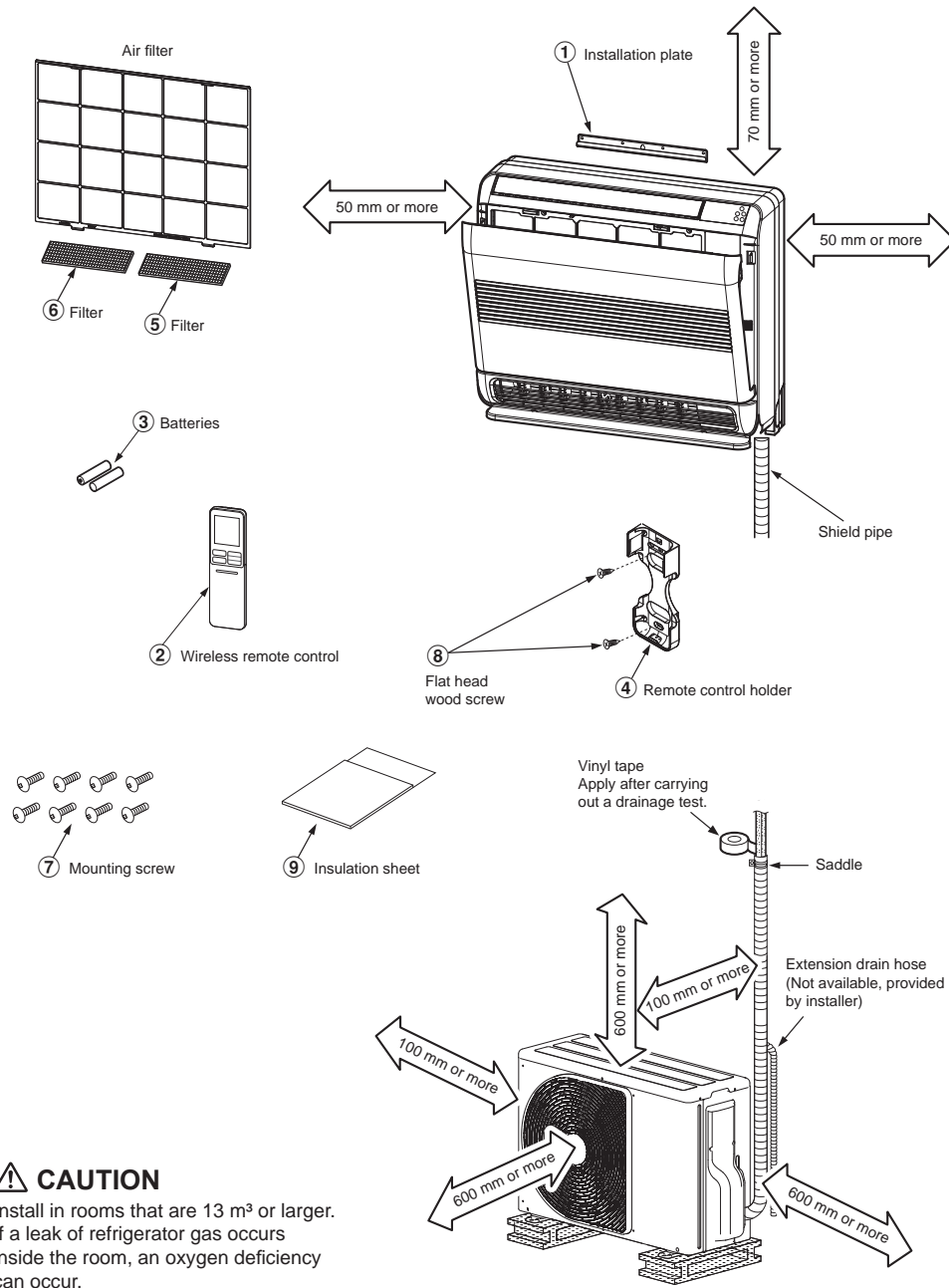

**CAUTION**  
 Install in rooms that are 13 m<sup>3</sup> or larger.  
 If a leak of refrigerator gas occurs  
 inside the room, an oxygen deficiency  
 can occur.

Do not allow the drain hose to get slack.

Cut the piping hole sloped slightly.

Make sure to run the drain hose sloped downward.

The auxiliary piping can be connected to the left, rear left, rear right, right, bottom right or bottom left.

Insulate the refrigerant pipes separately with insulation, not together.

8 mm thick heat resisting polyethylene foam

In case of right or left piping

Cut dot-line area

Before installing the wireless remote controller

- Loading Batteries
  1. Remove the battery cover.
  2. Insert 2 new batteries (AAA type) following the (+) and (-) positions.

② Wireless remote controller

③ Batteries

## 10-2. Optional Parts, Accessories and Tools

### 10-2-1. Optional Installation Parts

Part code	Parts name	Q'ty
Ⓐ	Refrigerant piping Liquid side : Ø6.35 mm Gas side : Ø9.52 mm (RAS-10, 13J2FVG-TR) : Ø12.7 mm (RAS-18J2FVG-TR)	One each
Ⓑ	Pipe insulating material (polyethylene foam, 8 mm thick)	1
Ⓒ	Putty, PVC tapes	One each



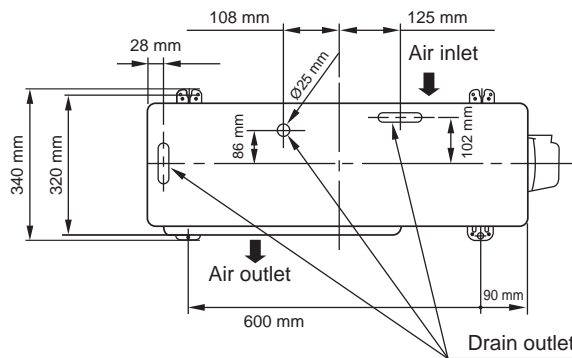











#### <Fixing bolt arrangement of outdoor unit>

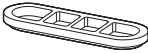

\* Drain nipple and cap water proof are packed in outdoor unit.

- Secure the outdoor unit with fixing bolts and nuts if the unit is likely to be exposed to a strong wind.
- Use Ø 8 mm or Ø 10 mm anchor bolts and nuts.
- If it is necessary to drain the defrost water, attach drain nipple ⑩ and cap waterproof ⑪ to the bottom plate of the outdoor unit before installing it.

## 10-2-2. Accessory and installation parts

ACCESSORY AND INSTALLATION PARTS			
No.	Parts name (Q'ty)	No.	Parts name (Q'ty)
①	 Installation plate* x 1	②	 Wireless remote control* x 1
③	 Battery x 2	④	 Remote control holder* x 1
⑤	 Filter**	⑥	 Filter**
⑦	 Mounting screw** $\varnothing 4 \times 25 \text{ l} \times 8$	⑧	 Flat head wood screw $\varnothing 3.1 \times 16 \text{ l} \times 2$
⑨	 Insulation sheet x 1 (for some models only)	⑩	 Drain nipple*** x 1 (for heating model only)
⑪	 Cap water proof*** x 2 (for some models only)	⑫	 Owner's Manual
⑬	 Installation Manual	⑭	 B Label x 2 (for Multi model)

\* The part may differ from that shown.

\*\* The number of parts may differ by model.

\*\*\* The part is packed with the outdoor unit.

### Air filters

Clean every 2 weeks.

1. Open the air inlet grille.
2. Remove the air filters.
3. Vacuum or wash and then dry them.
4. Reinstall the air filters and close the air inlet grille.

### Filter

Maintenance & Shelf-life

Clean every 3-6 months when dust tuck or covers the filter.

1. Recommend to use vacuum to clean by sucking the dusts which stick or dip inside the filter or use the blower to blow the dust go out through the filter.
2. If necessary to use water to clean, simply use the plain water to wash the filter, dry with the sunlight for 3-4 hours or until it completely dry. Nevertheless, use hair dryer to dry it. However, washing with water, it may reduce the performance of the filter.
3. Replace every 2 years or sooner. (contact your dealer to purchase new filter) (P/N : RB-A620DE)

Note: Filter life depends on the level of impurities in your operating environment. Higher levels of impurities may require more frequent cleaning and replacement. In all cases, we recommend an additional set of filters to improve the purifying and deodorizing performance of your air conditioner.

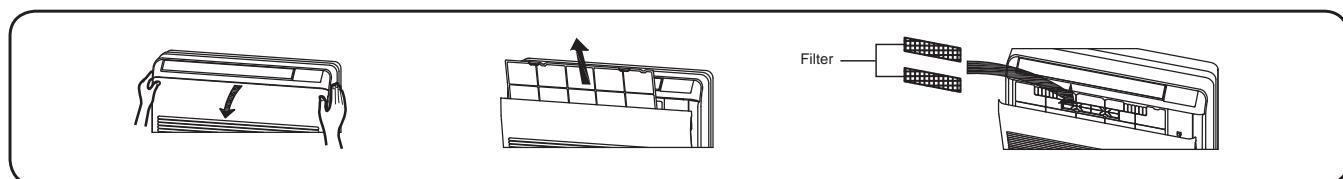







### 10-2-3. Installation/Serviceing Tools

#### Changes in the product and components

In the case of an air conditioner using R32, in order to prevent any other refrigerant from being charged accidentally, the service port diameter of the outdoor unit control valve (3 way valve) has been changed. (1/2 UNF 20 threads per inch)

- In order to increase the pressure resisting strength of the refrigerant piping flare processing diameter and size of opposite side of flare nuts has been changed. (for copper pipes with nominal dimensions 1/2 and 5/8)

#### New tools for R32(R410A)

New tools for R32(R410A)	Applicable to R22 model		Changes
Gauge manifold	✗		As pressure is high, it is impossible to measure by means of conventional gauge. In order to prevent any other refrigerant from being charged, each port diameter has been changed.
Charge hose	✗		In order to increase pressure resisting strength, hose materials and port size have been changed (to 1/2 UNF 20 threads per inch). When purchasing a charge hose, be sure to confirm the port size.
Electronic balance for refrigerant charging	○		As pressure is high and gasification speed is fast, it is difficult to read the indicated value by means of charging cylinder, as air bubbles occur.
Torque wrench (nominal diam. 1/2, 5/8)	✗		The size of opposite sides of flare nuts have been increased. Incidentally, a common wrench is used for nominal diameters 1/4 and 3/8.
Flare tool (clutch type)	○		By increasing the clamp bar's receiving hole, strength of spring in the tool has been improved.
Gauge for projection adjustment	—	—	Used when flare is made by using conventional flare tool.
Vacuum pump adapter	○		Connected to conventional vacuum pump. It is necessary to use an adapter to prevent vacuum pump oil from flowing back to the charge hose. The charge hose connecting part has two ports-one for conventional refrigerant (7/16 UNF 20 threads per inch) and one for R32(R410A). If the vacuum pump oil (mineral) mixes with R32(R410A) a sludge may occur and damage the equipment.
Gas leakage detector	✗		Exclusive for HFC refrigerant.

- Incidentally, the “refrigerant cylinder” comes with the refrigerant designation R32(R410A) and protector coating in the U.S's ARI specified rose color (ARI color code: PMS 507).
- Also, the “charge port and packing for refrigerant cylinder” require 1/2 UNF 20 threads per inch corresponding to the charge hose's port size.



## 10-3. Indoor Unit

### 10-3-1. Installation Place

- A place which provides the spaces around the indoor unit as shown in the diagram.
- A place where there are no obstacles near the air inlet and outlet.
- A place which allows easy installation of the piping to the outdoor unit.
- A place which allows the front panel to be opened.

#### CAUTION

- Direct sunlight to the indoor unit's wireless receiver should be avoided.
- The microprocessor in the indoor unit should not be too close to RF noise sources.  
(For details, see the owner's manual)

#### Remote control

- A place where there are no obstacles such as a curtain that may block the signal from the remote control.
- Do not install the remote control in a place exposed to direct sunlight or close to a heating source such as a stove.
- Keep the remote control at least 1 m apart from the nearest TV set or stereo equipment (This is necessary to prevent image disturbances or noise interference).
- The location of the remote control should be determined as shown below.

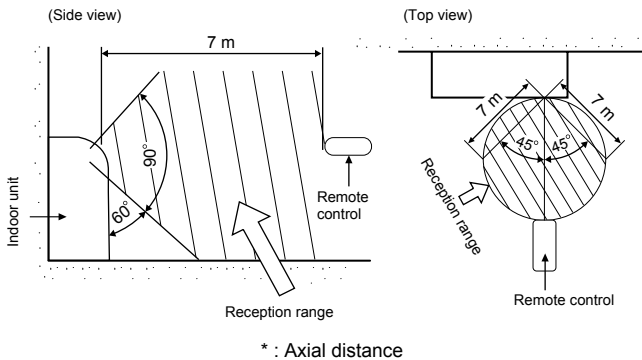

### 10-3-2. Cutting a Hole and Mounting Installation Plate

#### Cutting a hole

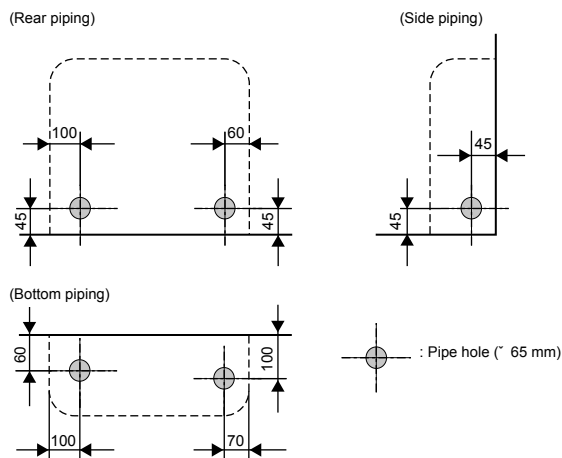

1. After determining the pipe hole position, drill the pipe hole (Ø65 mm) at a slight downward slant to the outdoor side.

#### NOTE

- When drilling a wall that contains a metal lath, wire lath or metal plate, be sure to use a pipe hole brim ring sold separately.

#### Mounting the installation plate and screw position

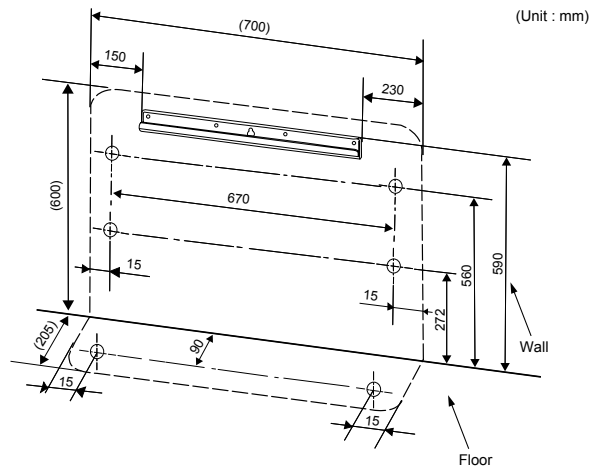

#### When the installation plate is directly mounted on the wall

1. Securely fit the installation plate onto the wall by screwing it in the upper and lower parts to hook up the indoor unit.
2. To mount the installation plate on a concrete wall with anchor bolts, use the anchor bolt holes as illustrated in the below figure.
3. Install the installation plate horizontally in the wall.

Installation plate  
(Keep horizontal direction)

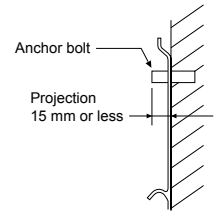
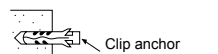
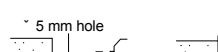
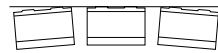

#### CAUTION

Failure to firmly install the unit may result in personal injury and property damage if the unit falls.

- In case of block, brick, concrete or similar type walls, make Ø5 mm holes in the wall.
- Insert clip anchors for appropriate mounting screws (7).

### 10-3-3. How to Install Indoor Unit

1. Remove the air inlet grille. Open the air inlet grille and remove the strap.
2. Remove the front panel (Remove the 4 screws).

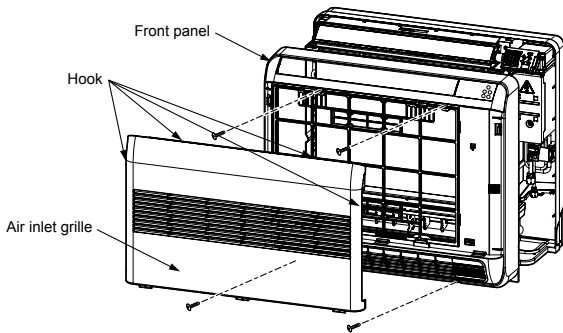

#### Layout of connection piping

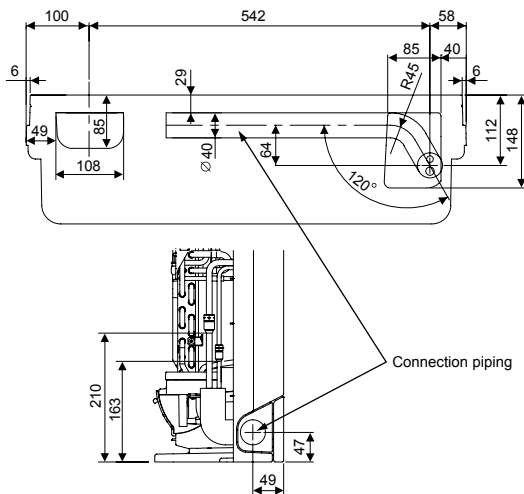

#### Treatment of piping connection

- 1) Check the flare nut connections for the gas leak with a gas leak detector or soap water.
- 2) To prevent gap in slit, fasten top and bottom with tape.
- 3) Slit is covered with tape.
- 4) Fasten with supplied Insulate sheet to prevent gap on the top of slit.

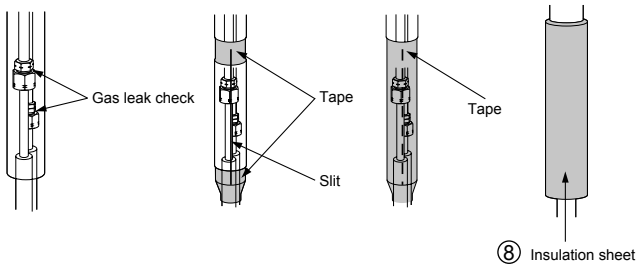

#### Drainage

1. Run the drain hose sloped downwards.

#### NOTE

- The hole should be made at a slight downward slant on the outdoor side.

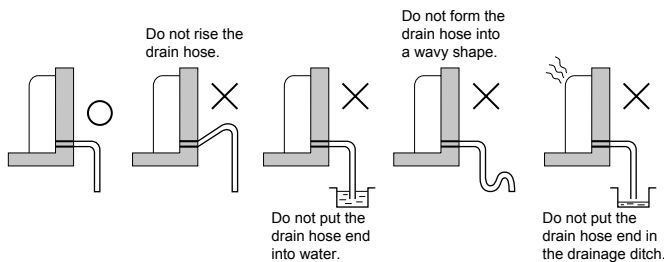

2. Put water in the drain pan and make sure that the water is drained out of doors.
3. When connecting extension drain hose, insulate the connecting part of extension drain hose with shield pipe.

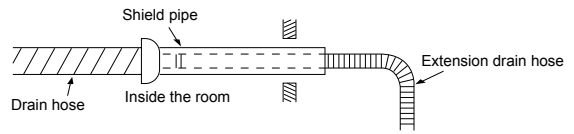

#### CAUTION

Arrange the drain pipe for proper drainage from the unit. Improper drainage can result in dew-dropping.

#### Wiring connection

Wiring of the connection cable is necessary to remove the front panel.

1. Remove the terminal cover and cord clamp.
2. Insert the connecting cable (according to the local rule) into the pipe hole on the wall.
3. Take out the connecting cable through the cable slot on the rear panel so that it protrudes about 50 cm from the front.
4. Insert the connecting cable fully into the terminal block and secure it tightly with screws.
5. Tightening torque : 1.2 N·m (0.12 kgf·m)
6. Secure the connecting cable with the cord clamp.
7. Fix the terminal cover, install the front panel and grille inlet.

#### CAUTION

- Be sure to refer to the wiring system diagram labeled inside the front panel.
- Check local electrical cords and also any specific wiring instructions or limitations.

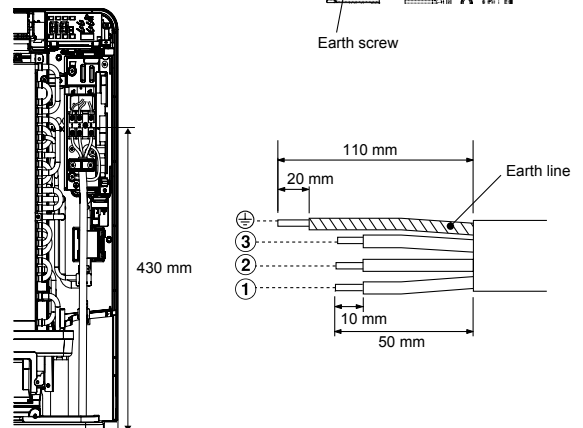
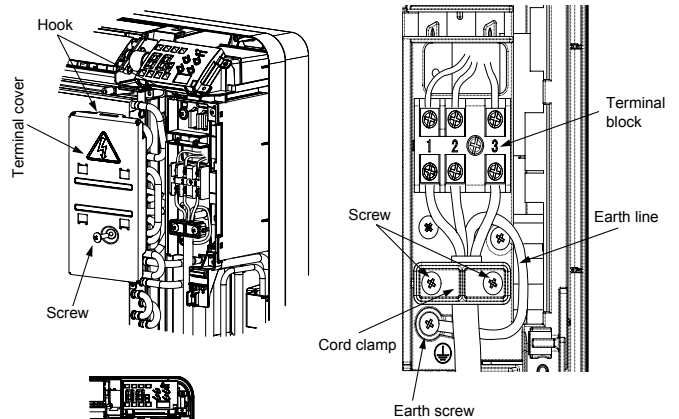

Stripping length of the connecting cable

#### NOTE

- Use stranded wire only.
- Wire type : H07RN-F or 60245 IEC66 (1.0 mm<sup>2</sup> or more)

### Mounting directly on the floor

- 1) Fix the leg of indoor unit on the floor with 2 mounting screws.
- 2) Fix the upper part of indoor unit on the wall with 4 mounting screws.

(Floor installation)

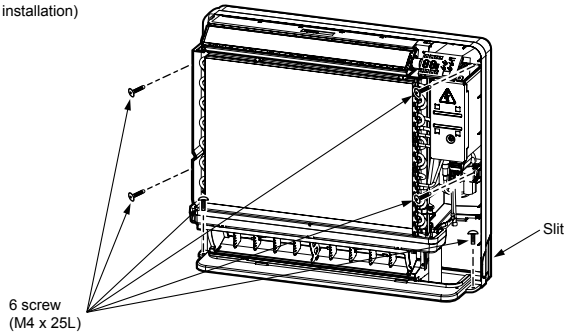

### NOTE

- In case the plinth is fixed to the wall, please make sure to cut out the slit on the left and right side of the main part.

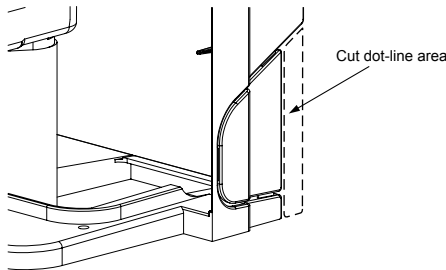

### Installation on the wall

- 1) Fix the installation plate on the wall with 4 mounting screws.
- 2) Hook the indoor unit on the installation plate.
- 3) Fix the upper part of indoor unit on the wall with 4 mounting screws.

(Wall installation)

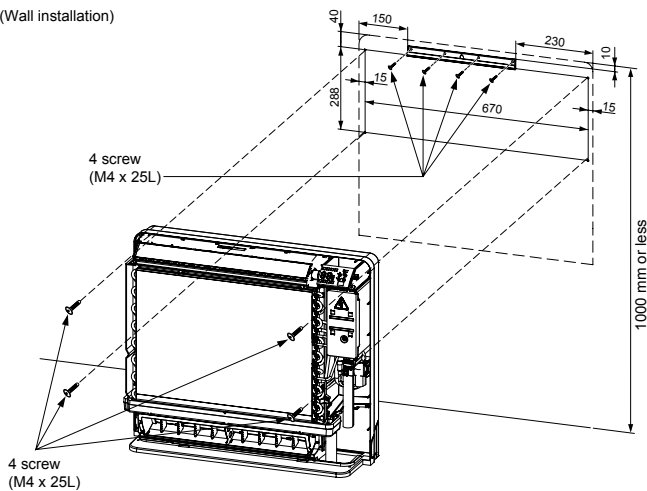

### CAUTION

Make sure to fix it at a designated position with the screws.  
Failure may result the damage of piping by the turning over of a set.

### 10-3-4. Concealed Installation

The special method to install the indoor unit bury in the wall is shown here. Please make sure to change to wall burying mode.

1. To switch to the wall burying mode
  - To switch to the wall burying mode, press and hold AIR OUTLET SELECT button for 20 seconds.
  - When the operation set up and 5 beep sounds. Then indication at Temperature indicator will light up for 5 seconds.
  - To cancel, press AIR OUTLET SELECT button for 20 seconds then, 5 beep sounds. Then indication at Temperature indicator will blinks for 5 seconds.
  - To prevent dewfall, above plate angle should be narrow.

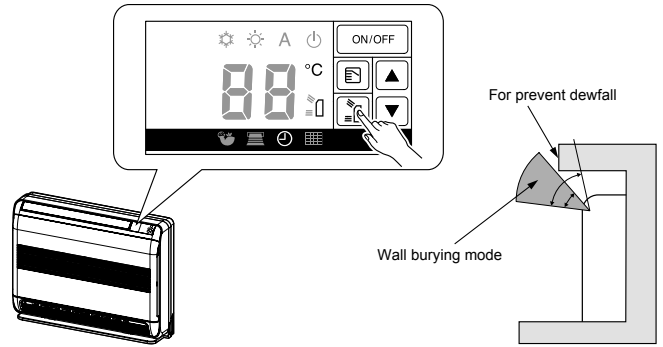

### 2. Wall hole size

Wall hole size should be enough to keep the distance with indoor unit as shown in the following figure.

(Front view)

(Unit : mm)

(Side view)

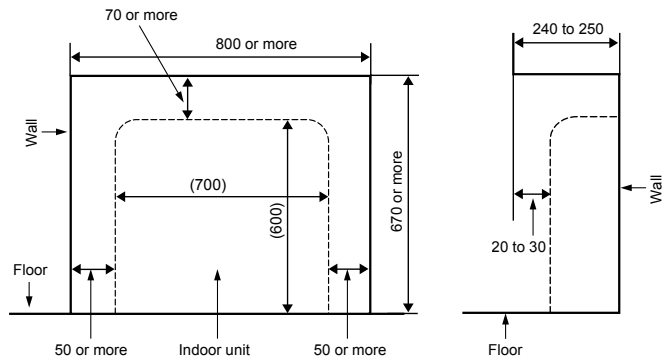

### 3. Installation using the supporting plate

- To install into the existing wall hole, if it is impossible to keep 20-30 mm of depth, use the supporting plate for securing the distance.
- Arrange the screw positions and supporting plate as shown in the figure.
- Be sure to switch to wall burying mode.

(Rear screws position)

(Side view)

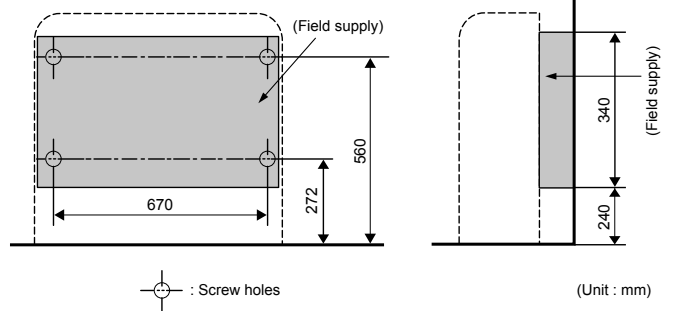

(Unit : mm)

4. In case of lattice establishment

- Follow the following figure, make sure to keep enough distance between lattice, frame and wall.
- Be sure to switch to wall burying mode.
- The lattice should be made of wood.
- Between the air inlet and outlet, should be divided with partition board.
- Be sure to establish the open part for RECEIVER.
- The open part of lattice must be open 70 % or more of the wall hole.
- The open part of lattice must be arranged uniformly.

(Top view)

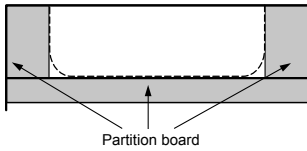

(Unit : mm)

(Front view)

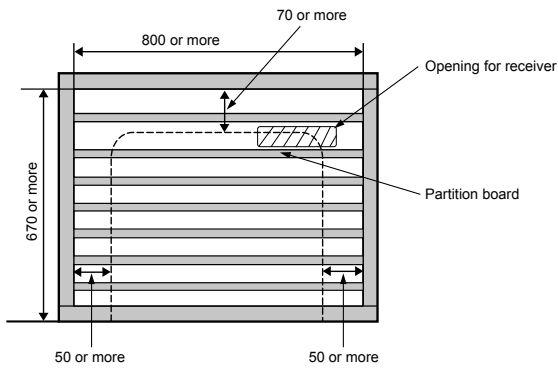

(Side view)

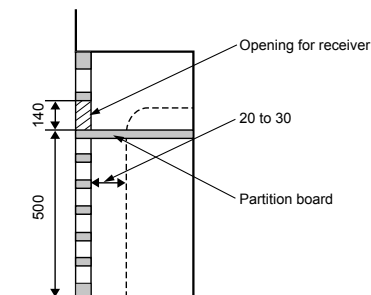

### 10-3-5. How to open the air inlet grille

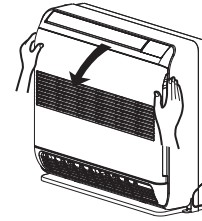

- Grip the air grille inlet by two hands at the handle positions.
- Pull the air inlet grille as the arrow direction.

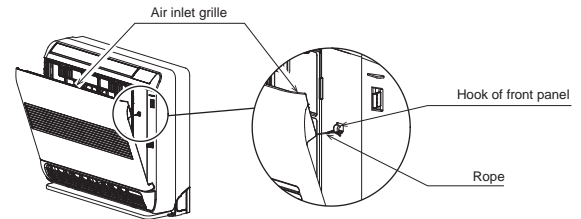

- The rope at the backside of air inlet grille is used for handling it on the front panel when you need to clean up the air filter.

### 10-3-6. How to use the heat insulation block

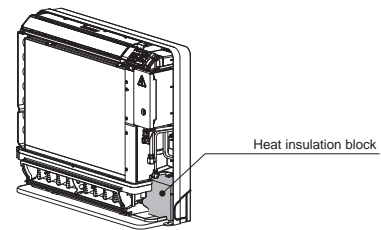

- Completely fill pipe by heat insulation block to protect water dew.
- Heat insulation block can be cut to an appropriate size and used.

## 10-4. Outdoor Unit

### 10-4-1. Installation place

- A place which provides enough spaces around the outdoor unit as shown in the diagram.
- A place which can bear the weight of the outdoor unit and does not allow an increase in noise level and vibration.
- A place where the operation noise and discharged air do not disturb your neighbors.
- A place which is not exposed to a strong wind.
- A place free of a leakage of combustible gases.
- A place which does not block a passage.
- When the outdoor unit is to be installed in an elevated position, be sure to secure its feet.
- The allowable length of the connecting pipe.

Model	RAS-10J2AVSG-TR,TR1	RAS-13J2AVSG-TR,TR1	RAS-18J2AVSG-TR
Chargeless	Up to 15 m	Up to 15 m	Up to 15 m
Maximum length	20 m	20 m	20 m
Additional refrigerant charging	16 - 20 m (20 g / 1 m)	16 - 20 m (20 g / 1 m)	16 - 20 m (20 g / 1 m)
Maximum refrigerant charging	0.65 kg	0.90 kg	1.20 kg

- The allowable height of outdoor unit installation site.

Model	RAS-10J2AVSG-TR,TR1	RAS-13J2AVSG-TR,TR1	RAS-18J2AVSG-TR
Maximum height	12 m	12 m	12 m

- A place where the drain water does not raise any problems

### Precautions for adding refrigerant

Use a scale having a precision with at least 10 g per index line when adding the refrigerant.  
Do not use a bathroom scale or similar instrument.

#### CAUTION

When the outdoor unit is installed in a place where the drain water might cause any problems, Seal the water leakage point tightly using a silicone adhesive or caulking compound.

### 10-4-2. Precautions about Installation in Regions with Snowfall and Cold Temperatures

- Do not use the supplied drain nipple for draining water. Drain the water from all the drain holes directly.
  - To protect the outdoor unit from snow accumulation, install a holding frame, and attach a snow protection hood and plate.
- \* Do not use a double-stacked design.

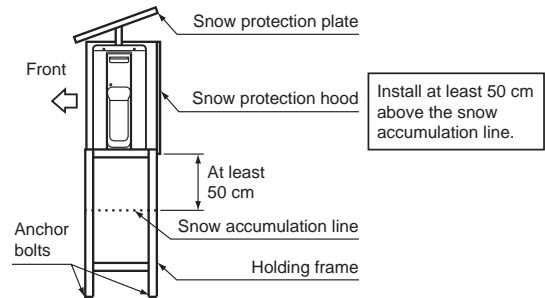

Fig. 10-4-1

#### CAUTION

1. Install the outdoor unit without anything blocking the air discharging.
2. When the outdoor unit is installed in a place exposed always exposed to strong wind like a coast or on a high storey of a building, secure the normal fan operation using a duct or a wind shield.
3. In particularly windy areas, install the unit such as to avoid admission of wind.
4. Installation in the following places may result in trouble.

Do not install the unit in such places.

- A place full of machine oil.
- A saline-place such as the coast.
- A place full of sulfide gas.
- A place where high-frequency waves are likely to be generated as from audio equipment, welders, and medical equipment.

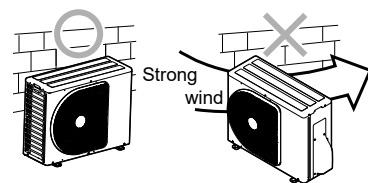

Fig. 10-4-2

## Draining the Water

- Holes are provided on the base plate of the outdoor unit to ensure that the defrost water produced during heating operations is drained off efficiently. If a centralized drain is required when installing the unit on a balcony or wall, follow the steps below to drain off the water.

1. Proceed with water-proofing by installing the water-proof rubber caps in the 2 elongated holes on the base plate of the outdoor unit.

[How to install the water-proof rubber caps]

- Place four fingers into each cap, and insert the caps into the water drain holes by pushing them into place from the underside of the base plate.
- Press down on the outer circumferences of the caps to ensure that they have been inserted tightly (Water leaks may result if the caps have not been inserted properly, if their outer circumferences lift up or the caps catch on or wedge against something.)

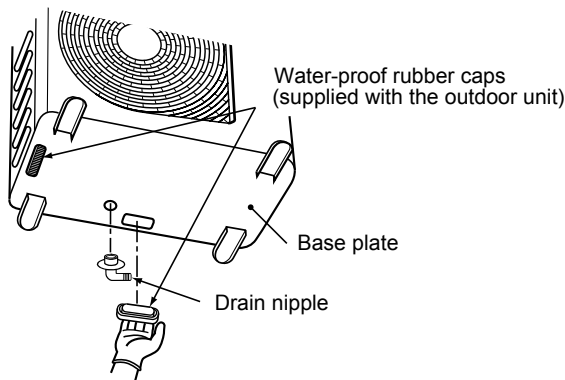

2. Install the drain nipple and a commercially available drain hose (with 16 mm inside diameter), and drain off the water.

(For the position where the drain nipple is installed, refer to the installation diagram of the indoor and outdoor units.)

- Check that the outdoor unit is horizontal, and route the drain hose at a downward sloped angle while ensuring that it is connected tautly.

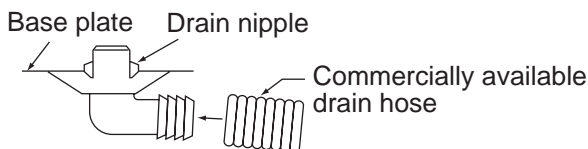

Do not use ordinary garden hose, but one can flatten and prevent water from draining.

## 10-4-3. Refrigerant piping connection <Flaring>

- Cut the pipe with a pipe cutter.
- Deburr the inside of the pipe at its end. Take steps to ensure that the removed burrs will not enter the pipe.
- Remove the flare nuts provided with the indoor and outdoor units, and insert them into the pipe.
- Flare the pipe. The projection margin of the pipe must be checked.
- Check that the flare has the appropriate shape.

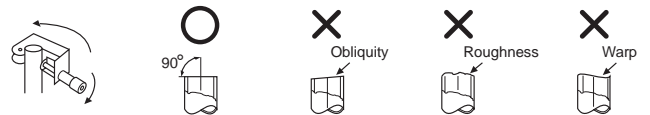

Fig. 10-4-3

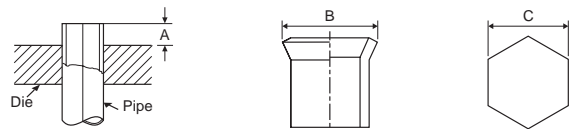

Fig. 10-4-4

Pipe		A		B		Flare Nut	
Outside diameter	Thickness	RIDGID (clutch type) R32 tool	IMPERIAL (wing nut type) R32 tool		C	Tighten torque	
mm	mm	mm	mm	mm	mm	N·m	kgf·m
6.35	0.8	0 to 0.5	1.5 to 2.0	9.1	17	14 to 18	1.4 to 1.8
9.52	0.8	0 to 0.5	1.5 to 2.0	13.2	22	33 to 42	3.3 to 4.2
12.7	0.8	0 to 0.5	2.0 to 2.5	16.6	26	50 to 62	5.0 to 6.2

### CAUTION

- Do not scratch the inner surface of the flared part when removing burrs.
- Flare processing under the condition of scratches on the inner surface of flare processing part will cause refrigerant gas leak.

### • Tightening torque for connection of flare pipe

The pressure of R32 or R410A is higher than R22 (Approx. 1.6 times). Therefore securely tighten the flare pipes which connect the outdoor unit and the indoor unit with the specified tightening torque using a torque wrench. If any flare pipe is incorrectly connected, it may cause not only a gas leakage but also trouble in the refrigeration cycle.

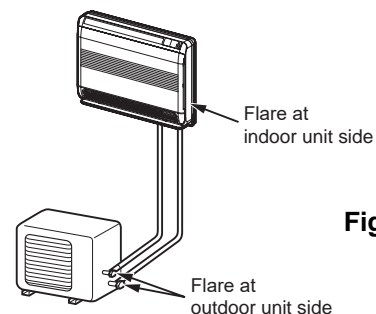

Fig. 10-4-5

## Evacuating

After the piping has been connected to the indoor unit, you can perform vacuuming together at once.

### VACUUMING

Evacuate the air in the connecting pipes and in the indoor unit using a vacuum pump. Do not use the refrigerant in the outdoor unit. For details, see the manual of the vacuum pump.

#### <Using a vacuum pump>

Be sure to use a vacuum pump with counter-flow prevention function so that inside oil of the pump does not flow backward into pipes of the air conditioner when the pump stops. (If oil inside of the vacuum pump enters into the air conditioner, which use R32 or R410A, refrigeration cycle trouble may result.)

1. Connect the charge hose from the manifold valve to the service port of the packed valve gas side.
2. Connect the charge hose to the port of the vacuum pump.
3. Open fully the low pressure side handle of the gauge manifold valve.
4. Operate the vacuum pump to start evacuating. Perform evacuating for about 15 minutes if the piping length is 20 meters. (15 minutes for 20 meters) (assuming a pump capacity of 27 liters per minute) Then confirm that the compound pressure gauge reading is -101 kPa (-76 cmHg).
5. Close the low pressure side valve handle of the gauge manifold valve.
6. Open fully the valve stem of the packed valves (both side of Gas and Liquid).
7. Remove the charging hose from the service port.
8. Securely tighten the caps on the packed valves.

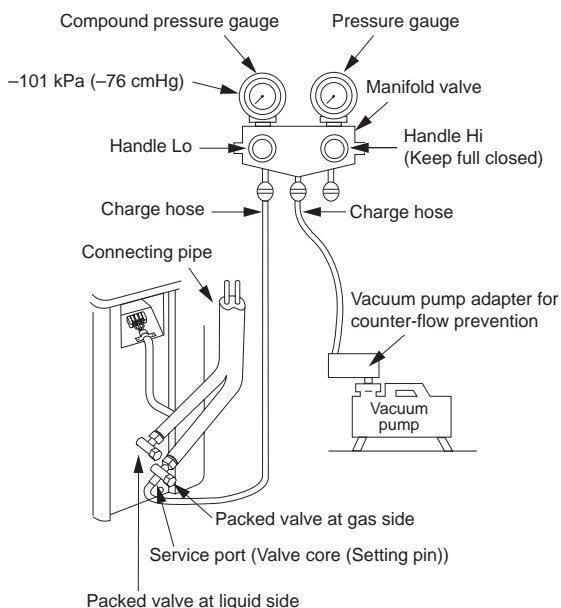

## CAUTION

- **KEEP IMPORTANT 7 POINTS FOR PIPING WORK**
  - (1) Take away dust and moisture (inside of the connecting pipes).
  - (2) Tighten the connections (between pipes and unit).
  - (3) Evacuate the air in the connecting pipes using a VACUUM PUMP.
  - (4) Check gas leak (connected points).
  - (5) Be sure to fully open the packed valves before operation.
  - (6) Reusable mechanical connectors and flared joints are not allowed indoors. When mechanical connectors are reused indoors, sealing parts shall be renewed. When flared joints are reused indoors, the flare part shall be refabricated.
  - (7) Don't operate air conditioner in case no refrigerant in the system.

#### <Packed valve handling precautions>

- Open the valve stem all the way out, but do not try to open it beyond the stopper.

Gas side (Ø12.70 mm)	50 to 62 N·m (5.0 to 6.2 kgf·m)
Gas side (Ø9.52 mm)	33 to 42 N·m (3.3 to 4.2 kgf·m)
Liquid side (Ø6.36 mm)	14 to 18 N·m (1.4 to 1.8 kgf·m)
Service port	14 to 18 N·m (1.4 to 1.8 kgf·m)

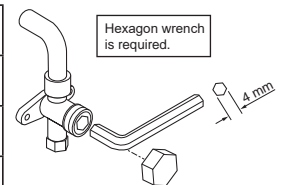

- Securely tighten the valve cap with torque in the following table

#### Wiring Connection

1. Remove the valve cover, the electric parts cover and the cord clamp from the outdoor unit.
2. Connect the connecting cable to the terminal as identified by the matching numbers on the terminal block of indoor and outdoor unit.
3. Insert the power cord and the connecting cable fully into the terminal block and secure it tightly with screws.
4. Use vinyl tape, etc. to insulate the cords which are not going to be used. Locate them so that they do not touch any electrical or metal parts.
5. Secure the power cord and the connecting cable with the cord clamp.
6. Attach the electric parts cover and the valve cover on the outdoor unit.

## Electrical Work

1. The supply voltage must be the same as the rated voltage of the air conditioner.
2. Prepare the power source for exclusive use with the air conditioner.

Model	RAS-10J2FVG-TR	RAS-13J2FVG-TR	RAS-18J2FVG-TR
Power source	220-240V ~ 50Hz	220-240V ~ 50Hz	220-240V ~ 50Hz
Maximum running current	6.75A	7.50A	10.40A
Circuit breaker rating	10A	10A	15A
Power cord	H07RN-F or 60245 IEC66 (1.5 mm <sup>2</sup> or more)		H07RN-F or 60245 IEC66 (2.5 mm <sup>2</sup> or more)
Connecting cable	H07RN-F or 60245 IEC66 (1.5 mm <sup>2</sup> or more)		

※ When using a multi-system outdoor unit is used, refer to the installation manual provided with the model concerned.

## Stripping length of the connecting cable

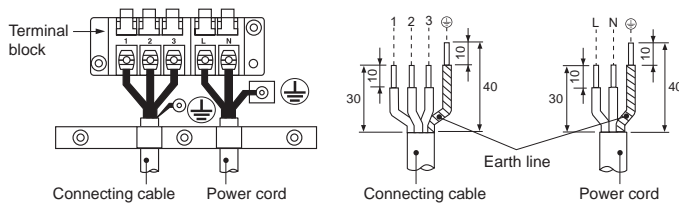

## 10-5. OTHERS

### 10-5-1. Gas Leak Test

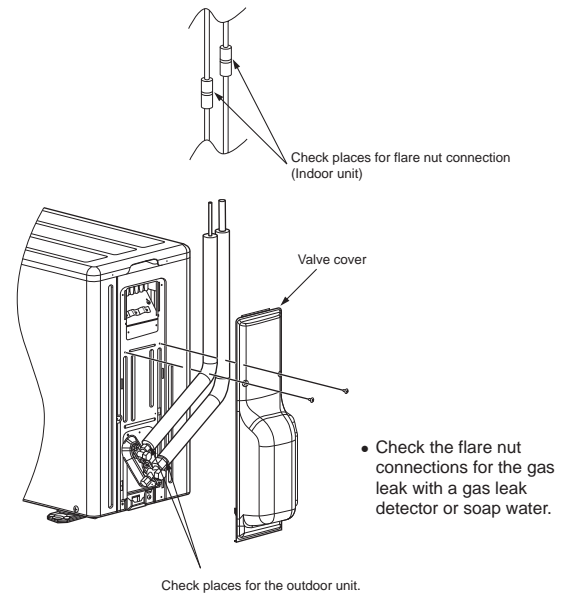

### 10-5-2. Setting of Remote Control Selector Switch

When two indoor units are installed in the separated rooms, it is not necessary to change the selector switches.

## CAUTION

1. The power supply must be same as the rated of air conditioner.
2. Prepare the power source for exclusive use with air conditioner.
3. Circuit breaker must be used for the power supply line of this air conditioner.
4. Be sure to comply power supply and connecting cable for size and wiring method.
5. Every wire must be connected firmly.
6. Perform wiring works so as to allow a general wiring capacity.
7. Wrong wiring connection may cause some electrical part burn out.
8. Incorrect or incomplete wiring is carried out, it will cause an ignition or smoke.
9. This product can be connected to main power supply.  
Connection to fixed wiring : A switch which disconnects all poles and has a contact separation at least 3 mm must be incorporated in the fixed wiring.

### Remote control selector switch

- When two indoor units are installed in the same room or adjacent two rooms, if operating a unit, two units may receive the remote control signal simultaneously and operate. In this case, the operation can be preserved by setting either one indoor unit or remote control to B setting (Both are set to A setting in factory shipment).
- The remote control signal is not received when the settings of indoor unit and remote control are different.
- There is no relation between A setting/B setting and A room/B room when connecting the piping and cables.



### 10-5-3. Remote Control A-B Selection

To separate using of remote control for each indoor unit in case of 2 air conditioners are installed nearby.

#### Remote Control B Setup.

1. Push and hold CHECK button on the Remote Control by the tip of the pencil. "00" will be shown on the display (Picture ①).
2. Press MODE during pushing CHECK. "B" will show on the display and "00" will disappear and the air conditioner will turn OFF. The Remote Control B is memorized (Picture ②).

Note : 1. Repeat previous step to reset Remote Control to be A.  
 2. Remote Control A has not "A" display.  
 3. Default setting of Remote Control from factory is A.

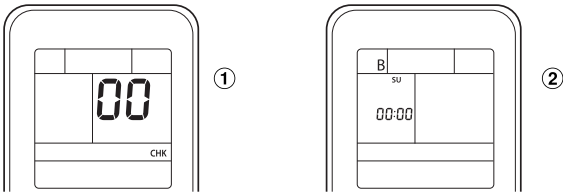

#### Unit B setup.

Press and hold MODE button for more than 20 seconds.  
 When A setup changed to B setup : 5 beeps will sound and operation lamp blinks for 5 seconds.  
 When B setup changed to A setup : 5 beep will sound.

### 10-5-4. Test Operation

To switch the TEST RUN (COOL) mode, press OPERATION button for 10 seconds (The beeper will make a short beep).

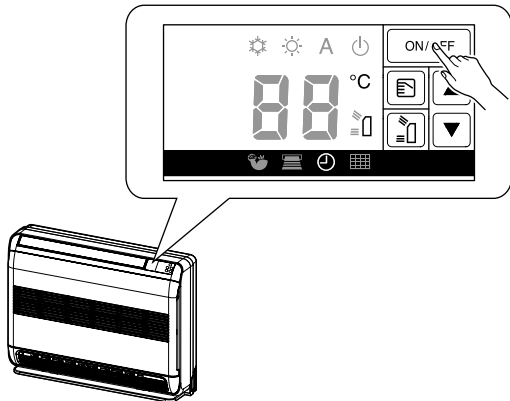

### 10-5-5. Auto Restart Setting

This product is designed so that, after a power failure, it can restart automatically in the same operating mode as before the power failure.

#### Information

The product are shipped with Auto Restart function in the OFF position. Turn it ON as required.

#### How to turn ON the Auto Restart Function

- Press and hold the [OPERATION] button on the indoor unit for 3 seconds (3 beep sounds and OPERATION lamp blink 5 time/sec for 5 seconds).

#### How to turn OFF the Auto Restart Function

- Press and hold the [OPERATION] button on the indoor unit for 3 seconds (3 beep sounds but OPERATION lamp does not blink).

#### NOTE :

- In case of NO timer or OFF timer are set, AUTO RESTART OPERATION does not activate.

## 11. HOW TO DIAGNOSE THE TROUBLE

The pulse motor circuits are mounted to both indoor and outdoor units. Therefore, diagnose troubles according to the trouble diagnosis procedure as described below. (Refer to the check points in servicing written on the wiring diagrams attached to the indoor/outdoor units.)

Table 11-1

No.	Troubleshooting Procedure
1	First Confirmation
2	Primary Judgment
3	Judgment by Flashing LED of Indoor Unit
4	Self-Diagnosis by Remote Controller
5	Judgment of Trouble by Every Symptom

No.	Troubleshooting Procedure
6	Check Code 1C and 1E
7	How to Diagnose Trouble in Outdoor Unit
8	How to Check Simply the Main Parts
9	How to Simply Judge Whether Outdoor Fan Motor is Good or Bad

## 11-1. First Confirmation

### 11-1-1. Confirmation of Power Supply

Confirm that the power breaker operates (ON) normally.

### 11-1-2. Confirmation of Power Voltage

Confirm that power voltage is AC 220–230–240 ± 10%.

If power voltage is not in this range, the unit may not operate normally.

### 11-1-3. Operation Which is not a Trouble (Program Operation)

For controlling the air conditioner, the program operations are built in the microcomputer as described in the following table.

If a claim is made for running operation, check whether or not it meets to the contents in the following table.

When it does, we inform you that it is not trouble of equipment, but it is indispensable for controlling and maintaining of air conditioner.

Table 11-1-1

No.	Operation of air conditioner	Description
1	When power breaker is turned "ON", the operation indicator (Green) of the indoor unit flashes.	The operation indicator of the indoor unit flashes when power source is turned on. If [START/STOP] button is operated once, flashing stops. (Flashes also in power failure)
2	Compressor may not operate even if the room temperature is within range of compressor-ON.	The compressor does not operate while compressor restart delay timer (3-minutes timer) operates. The same phenomenon is found after power source has been turned on because 3-minutes timer operates.
3	In Dry and ECO mode, FAN (air flow) display does not change even though FAN (air flow select) button is operated.	The air flow indication is fixed to [AUTO].
4	Increasing of compressor motor speed stops approx. 30 seconds after operation started, and then compressor motor speed increases again approx. 30 seconds after.	For smooth operation of the compressor, the compressor motor speed is restricted to Max. 41 rps for 2 minutes, and Max.91 rps for 2 minutes to 3 minutes, respectively after the operation has started.
5	In AUTO mode, the operation mode is changed.	After selecting Cool or Heat mode, select an operation mode again if the compressor keeps stop status for 15 minutes.
6	In HEAT mode, the compressor motor speed does not increase up to the maximum speed or decreases before the temperature arrives at the set temperature.	The compressor motor speed may decrease by high-temp. release control (Release protective operation by temp.-up of the indoor heat exchanger) or current release control.

## 11-2. Primary Judgment

To diagnose the troubles, use the following methods.

- 1) Judgment by flashing LED of indoor unit
- 2) Self-diagnosis by service check remote controller
- 3) Judgment of trouble by every symptom

Firstly use the method 1) for diagnosis. Then, use the method 2) or 3) to diagnose the details of troubles.

## 11-3. Judgment by Flashing LED of Indoor Unit

While the indoor unit monitors the operation status of the air conditioner, if the protective circuit operates, the contents of self-diagnosis are displayed with block on the indoor unit indication section.

Table 11-3-1

	Item	Check code	Block display	Description for self-diagnosis														
<div style="border: 1px solid black; padding: 5px; width: fit-content;">Indoor indication lamp flashes.</div> <div style="margin-left: 20px;">↓</div> <div style="border: 1px solid black; padding: 5px; width: fit-content;">Which lamp does flash?</div> <div style="margin-left: 20px;">↓</div> <div style="margin-left: 20px;">→</div>	A	—	OPERATION Flashing display (1 Hz)	Power failure (when power is ON)														
	B	00	OPERATION Flashing display (5 Hz)	Protective circuit operation for indoor P.C. board														
	C	01	OPERATION TIMER (White) Flashing display (5 Hz)	Protective circuit operation for connecting cable and serial signal system														
	D	02	OPERATION Flashing display (5 Hz)	Protective circuit operation for outdoor P.C. board														
	E	03	OPERATION TIMER Flashing display (5 Hz)	Protective circuit operation for others (including compressor)														
	F	33	<table border="1" style="border-collapse: collapse; width: 100%;"> <tr> <td style="width: 50%;">OPERATION</td> <td style="width: 50%;">TIMER</td> <td></td> </tr> <tr> <td>Normal</td> <td>Normal</td> <td>Nothing</td> </tr> <tr> <td>Flash 1 Hz</td> <td>None</td> <td>Current release</td> </tr> <tr> <td>Flash 2 Hz 2 times every 1 sec</td> <td>None</td> <td>TD release</td> </tr> <tr> <td>None</td> <td>Flash 1 Hz</td> <td>TC release</td> </tr> </table>	OPERATION	TIMER		Normal	Normal	Nothing	Flash 1 Hz	None	Current release	Flash 2 Hz 2 times every 1 sec	None	TD release	None	Flash 1 Hz	TC release
OPERATION	TIMER																	
Normal	Normal	Nothing																
Flash 1 Hz	None	Current release																
Flash 2 Hz 2 times every 1 sec	None	TD release																
None	Flash 1 Hz	TC release																

### NOTES :

1. The contents of items B and C and a part of item E are displayed when air conditioner operates.
2. When item B and C, and item B and a part of item E occur concurrently, priority is given to the block of item B.
3. The check codes can be confirmed on the remote controller for servicing.

## 11-4. Self-Diagnosis by Remote Controller (Check Code)

1. If the lamps are indicated as shown B to E in Table 11-4-1, execute the self-diagnosis by the remote controller.
2. When the remote controller is set to the service mode, the indoor controller diagnoses the operation condition and indicates the information of the self-diagnosis on the display of the remote controller with the check codes. If a fault is detected, all lamps on the indoor unit will flash at 5Hz and it will beep for 10 seconds (Beep, Beep, Beep... ). The timer lamp usually flashes (5Hz) during self-diagnosis.

### 11-4-1. How to Use Remote Controller in Service Mode

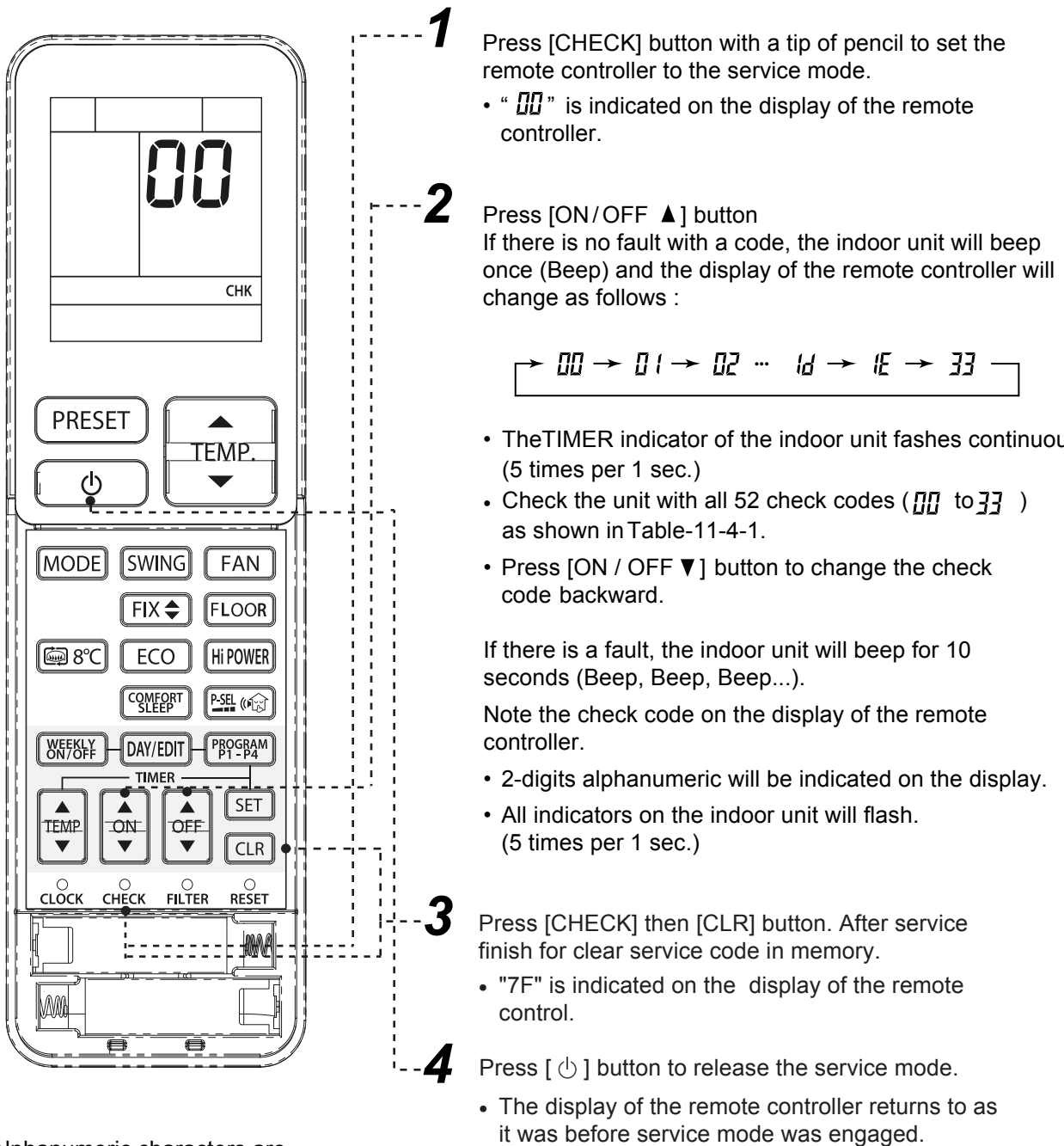

Alphanumeric characters are used for the check codes.

5 is 5.	6 is 6.
A is A.	b is B.
C is C.	d is D.

Fig. 11-4-1

## 11-4-2 Caution at Servicing

1. After using the service mode of remote controller finished, press the [ ⏻ ] button to reset the remote controller to normal function.
2. After finished the diagnosis by the remote controller, turn OFF power supply and turn its ON again to reset the air conditioner to normal operation. However, the check codes are not deleted from memory of the microcomputer.
3. After servicing finished, press [ CLR ] button of remote controller under service mode status to send code "7F" to the indoor unit. The check code stored in memory is cleared.

Table 11-4-1

Block distinction		Operation of diagnosis function				Action and Judgment
Check code	Block	Check code	Cause of operation	Air conditioner status	Display flashing error	
00	Indoor P.C. board.	01	TA sensor ; The room temperature sensor is short-Circuit or disconnection.	Operation continues.	Flashes when error is detected.	1. Check the sensor TA and connection. 2. In case of the sensor and its connection is normal, check the P.C. board.
		02	TC sensor ; The heat exchanger temperature sensor of the indoor unit is out of place, disconnection, short-circuit or migration.	Operation continues.	Flashes when error is detected.	1. Check the sensor TC and connection. 2. In case of the sensor and its connection is normal, check the P.C. board.
		0E	Gas detector sensor failure	Outdoor Unit "OFF" Indoor Unit continue fan only operation for 250 minute or "OFF".	Flashes when error is detected.	1. Check Gas sensor shortage / open. 2. Check Gas sensor disconnect.
		11	Fan motor of the indoor unit is failure, lock-rotor, short-circuit, disconnection, etc. Or its circuit on P.C. board has problem.	All OFF	Flashes when error is detected.	1. Check the fan motor and connection. 2. In case of the motor and its connection is normal, check the P.C. board.
		12	Other trouble on the indoor P.C. board.	Depend on cause of failure.	Depend on cause of failure.	1. Reset power supply. 2. Replace P.C. board.
		25	Gas detector sensor life time	Operation continues.	Flashes when error is detected.	Replace new sensor.

Block distinction		Operation of diagnosis function				Action and Judgment
Check code	Block	Check code	Cause of operation	Air conditioner status	Display flashing error	
01	Serial signal and connecting cable.	04	1) Defective wiring of the connecting cable or miss-wiring. 2) Operation signal has not send from the indoor unit when operation start. 3) Outdoor unit has not send return signal to the indoor unit when operation started. 4) Return signal from the outdoor unit is stop during operation. <ul style="list-style-type: none"> <li>• Some protector (hardware, if exist) of the outdoor unit open circuit of signal.</li> <li>• Signal circuit of indoor P.C. board or outdoor P.C. board is failure in some period.</li> </ul>	Indoor unit operates continue. Outdoor unit stop.	Flashes when error is detected. Flashing stop and outdoor unit start to operate when the return signal from the outdoor unit is normal.	1) to 3) The outdoor unit never operate. <ul style="list-style-type: none"> <li>• Check connecting cable and correct if defective wiring.</li> <li>• Check 25A fuse of inverter P.C. board.</li> <li>• Check 3.15A fuse of inverter P.C. board.</li> <li>• Check operation signal of the indoor unit by using diode. Measure voltage at terminal block of the indoor unit between No.2 and No.3 (or L2 and S) If signal is varied 15-60V continuously, replace inverter P.C. board. If signal is not varied, replace indoor P.C. board.</li> </ul> 4) The outdoor unit abnormal stop at some time. <ul style="list-style-type: none"> <li>• If the other check codes are found concurrently, check them together.</li> <li>• Check protector (hardware) such as Hi-Pressure switch, Thermal-Relay, etc.</li> <li>• Check refrigerant amount or any possibility case which may caused high temperature or high pressure.</li> <li>• Check operation signal of the indoor unit by using diode. Measure voltage at terminal block of the indoor unit between No.2 and No.3 (or L2 and S) If signal is varied 15-60V continuously, replace inverter P.C. board. If signal is not varied, replace indoor P.C. board.</li> </ul>

**Note : Operation signal of the indoor unit shall be measured in the sending period as picture below.**

**Sending signal of the indoor unit when have not return signal from the outdoor unit.**

\* Signal send only 1 minute and stop. Because of return signal from outdoor unit has not received.  
 \*\* Signal resend again after 3 minutes stop. And the signal will send continuously.  
 \*\*\* 1 minute after resending, the indoor unit display flashes error.

Block distinction		Operation of diagnosis function				Action and Judgment
Check code	Block	Check code	Cause of operation	Air conditioner status	Display flashing error	
02	Outdoor P.C. board	14	Current on inverter circuit is over limit in short time. <ul style="list-style-type: none"> <li>Inverter P.C. board is failure, IGBT shortage, etc.</li> <li>Compressor current is higher than limitation, lock rotor, etc.</li> </ul>	All OFF	Flashes after error is detected 8 times*.	<ol style="list-style-type: none"> <li>Remove connecting lead wire of the compressor, and operate again.</li> <li>If outdoor fan does not operate or operate but stop after some period, replace the inverter P.C. board.</li> <li>If outdoor fan operates normally, measure 3-Phase output of inverter P.C. board (150-270VAC) at the connecting lead wire of compressor.</li> <li>If 3-Phase output is abnormal, replace inverter P.C.Board.</li> <li>If 3-Phase output is normal, replace compressor. (lock rotor, etc.)</li> </ol>
		15	Compressor position-detect circuit error or short-circuit between winding of compressor.	All OFF	Flashes after error is detected 8 times*.	<ol style="list-style-type: none"> <li>Remove connecting lead wire of the compressor, and operate again.</li> <li>If outdoor fan does not operate or operation but stop after some period, replace the inverter P.C. board.</li> <li>If outdoor fan operates normally, measure resistance of compressor winding. If circuit is shortage, replace the compressor.</li> </ol>
		17	Current-detect circuit of inverter P.C. board error.	All OFF	Flashes after error is detected 4 times*.	Even if trying to operate again, all operations stop, replace inverter P.C. board.
		18	TE or TS sensor; abnormal. Out of place, disconnection, shortage, or misconnection (TE sensor is connected to TS connector, TS sensor is connected to TE sensor connector)  TE sensor; Outdoor heat exchanger temperature sensor  TS sensor; Suction pipe temperature sensor	All OFF	Flashes after error is detected 4 times*.	<ol style="list-style-type: none"> <li>Check sensors, TE, TS connection. In case of sensors and it's connection is normal, check the inverter P.C. board</li> <li>Check 4way valve operation/position. In case TE, TS detected temperature relationship are different from normal operation, "18" might be detected.</li> </ol>
		19	TD sensor ; Discharge pipe temperature sensor is disconnection or shortage.	All OFF	Flashes after error is detected 4 times*.	<ol style="list-style-type: none"> <li>Check sensors TD and connection.</li> <li>In case of the sensor and its connection is normal, check the inverter P.C. board.</li> </ol>
		1A	Outdoor fan failure or its drive-circuit on the inverter P.C. board failure.	All OFF	Flashes after error is detected 8 times*.	<ol style="list-style-type: none"> <li>Check the motor, measure winding resistance, shortage or lock rotor.</li> <li>Check the inverter P.C. board.</li> </ol>
		1b	TO sensor ; The outdoor temperature sensor is disconnection or shortage.	Operation continues.	Record error after detected 4 times*. But does not flash display.	<ol style="list-style-type: none"> <li>Check sensors TO and connection.</li> <li>In case of the sensor and its connection is normal, check the inverter P.C. board.</li> </ol>



Block distinction		Operation of diagnosis function				Action and Judgment
Check code	Block	Check code	Cause of operation	Air conditioner status	Display flashing error	
02		11	Compressor drive output error. (Relation of voltage, current and frequency is abnormal) <ul style="list-style-type: none"> <li>Overloading operation of compressor caused by over-charge refrigerant, P.M.V. failure, etc.</li> <li>Compressor failure (High current).</li> </ul>	All OFF	Flashes after error is detected 8 times*.	<ol style="list-style-type: none"> <li>Check installation conditions such as packed valve opening, refrigerant amount and power supply (rate <math>\pm 10\%</math>, both of operation and non operation condition).</li> <li>Check P.M.V. by measure the resistance of the coil and confirm its operation (sound of initial operation, etc.)</li> <li>Observe any possibility cause which may affect operation load of compressor.</li> <li>Operate again. If compressor operation is failure when 20 seconds passed (count time from operation starting of compressor), replace compressor.</li> </ol>
<p>* 4, 8, 11 or 18 times ; When first error is detected, error is count as 1 time, then once operation is stop and re-started.            After re-starting operation within 6 minutes, if same error is detected, error count is add (count become 2 times)            When error count comes 4, 8, 11 or 18 times, record error to check code. But after re-starting operation, if no error is detected and air conditioner can operate more than 6 minutes, error count is cleared.</p>						
03	The others (including compressor)	07	Return signal of the outdoor unit has been sent when operation start. But after that, signal is stop some time. <ul style="list-style-type: none"> <li>Instantaneous power failure.</li> <li>Some protector (hardware) of the outdoor unit open circuit of signal.</li> <li>Signal circuit of indoor P.C. board or outdoor P.C. board is failure in some period.</li> </ul>	Indoor unit operates continue. Outdoor unit stop.	Flashes when error is detected. Flashing stop and outdoor unit start to operate when the return signal from the outdoor unit is normal.	<ol style="list-style-type: none"> <li>Check power supply (Rate <math>\pm 10\%</math>)</li> <li>If the air conditioner repeat operates and stop with interval of approx. 10 to 40 minutes.               <ul style="list-style-type: none"> <li>Check protector (hardware) such as Hi-Pressure switch, Thermal-Relay, etc.</li> <li>Check refrigerant amount, packed valve opening and any possibility cause which may affect high temperature or high pressure.</li> </ul> </li> <li>Check operation signal of the indoor unit by using diode. Measure voltage at terminal block of the indoor unit between No.2 and No.3 (or L2 and S)                If signal is varied 15-60V continuously, replace inverter P.C. board.                If signal is not varied, replace indoor P.C. board.</li> </ol>

Block distinction		Operation of diagnosis function				Action and Judgment
Check code	Block	Check code	Cause of operation	Air conditioner status	Display flashing error	
03		1D	Compressor does not rotate. Because of missed wiring, missed phase or shortage.	All OFF	Flashes after error is detected 8 times*.	<ol style="list-style-type: none"> <li>1. Remove connecting lead wire of the compressor, and operate again.</li> <li>2. If outdoor fan does not operate or operation but stop after some period, replace the inverter P.C. board.</li> <li>3. If outdoor fan operates normally, measure 3-Phase output of inverter P.C. board (150-270VAC) at the connecting lead wire of compressor.</li> <li>4. If 3-Phase output is abnormal, replace inverter P.C.Board.</li> <li>5. If 3-Phase output is normal, measure resistance of compressor winding.</li> <li>6. If winding is shortage, replace the compressor.</li> </ol>
		1E	Discharge temperature exceeded 117°C.	All OFF	Flashes after error is detected 4 times*.	<ol style="list-style-type: none"> <li>1. Check sensors TD.</li> <li>2. Check refrigerant amount.</li> <li>3. Check P.M.V. by measure the resistance of the coil and confirm its operation (sound of initial operation, etc.)</li> <li>4. Observe any possibility cause which may affect high temperature of compressor.</li> </ol>
		1F	Compressor is high current though operation Hz is decreased to minimum limit. <ul style="list-style-type: none"> <li>• Installation problem.</li> <li>• Instantaneous power failure.</li> <li>• Refrigeration cycle problem.</li> <li>• Compressor break down.</li> <li>• Compressor failure (High current).operation, etc.)</li> </ul>	All OFF	Flashes after error is detected 8 times*.	<ol style="list-style-type: none"> <li>1. Check installation conditions such as packed valve opening, refrigerant amount and power supply (rate <math>\pm 10\%</math>, both of operation and non operation condition).</li> <li>2. Check P.M.V. by measure the resistance of the coil and confirm its operation (sound of initial operation, etc.)</li> <li>3. Observe any possibility cause which may affect high current of compressor.</li> <li>4. If 1, 2 and 3 are normal, replace compressor.</li> </ol>
<p>* 4, 8, 11 or 18 times ; When first error is detected, error is count as 1 time, then once operation is stop and re-started. After re-starting operation within 6 minutes, if same error is detected, error count is add (count become 2 times) When error count comes 4, 8, 11 or 18 times, record error to check code. But after re-starting operation, if no error is detected and air conditioner can operate more than 6 minutes, error count is cleared.</p>						

Block distinction		Operation of diagnosis function				Action and Judgment
Check code	Block	Check code	Cause of operation	Air conditioner status	Display flashing error	
03	The others (including compressor)	21	<p>Return signal of the outdoor unit has been sent when operation start. But after that, signal is stop some time.</p> <ul style="list-style-type: none"> <li>Instantaneous power failure.</li> <li>Some protector (hardware) of the outdoor unit open circuit of signal.</li> <li>Signal circuit of indoor P.C. board or outdoor P.C. board is failure in some period.</li> <li>TE, TC high temperature TE for cooling operation TC for heating operation.</li> </ul>	Indoor unit operates continue. Outdoor unit stop.	<p>Flashes when error is detected 11 times*.</p> <p>Flashing stop and outdoor unit start to operate when the return signal from the outdoor unit is normal.</p>	<ol style="list-style-type: none"> <li>Check power supply (Rate <math>\pm 10\%</math>)</li> <li>If the air conditioner repeat operate and stop with interval of approx. 10 to 40 minutes. <ul style="list-style-type: none"> <li>Check protector (hardware) such as Hi-Pressure switch, Thermal-Relay, etc.</li> <li>Check refrigerant amount, packed valve opening and any possibility cause which may affect high temperature or high pressure.</li> </ul> </li> <li>Check operation signal of the indoor unit by using diode. Measure voltage at terminal block of the indoor unit between No.2 and No.3 (or L2 and S) If signal is varied 15-60V continuously, replace inverter P.C. board. If signal is not varied, replace indoor P.C. board.</li> <li>Check and clean heat exchanger area Indoor and Outdoor unit.</li> </ol>
<p>* 4, 8, 11 or 18 times ; When first error is detected, error is count as 1 time, then once operation is stop and re-started. After re-starting operation within 6 minutes, if same error is detected, error count is add (count become 2 times) When error count comes 4, 8, 11 or 18 times, record error to check code. But after re-starting operation, if no error is detected and air conditioner can operate more than 6 minutes, error count is cleared.</p>						

## 11-5. Judgment of Trouble by Every Symptom

### 11-5-1. Indoor Unit (Including Remote Controller)

#### (1) Power is not turned on (Does not operate entirely)

##### <Primary check>

1. Is the supply voltage normal?
2. Is the normal voltage provided to the outdoor unit?
3. Is the crossover cable connected properly?
4. Is the fuse (F01) blown?

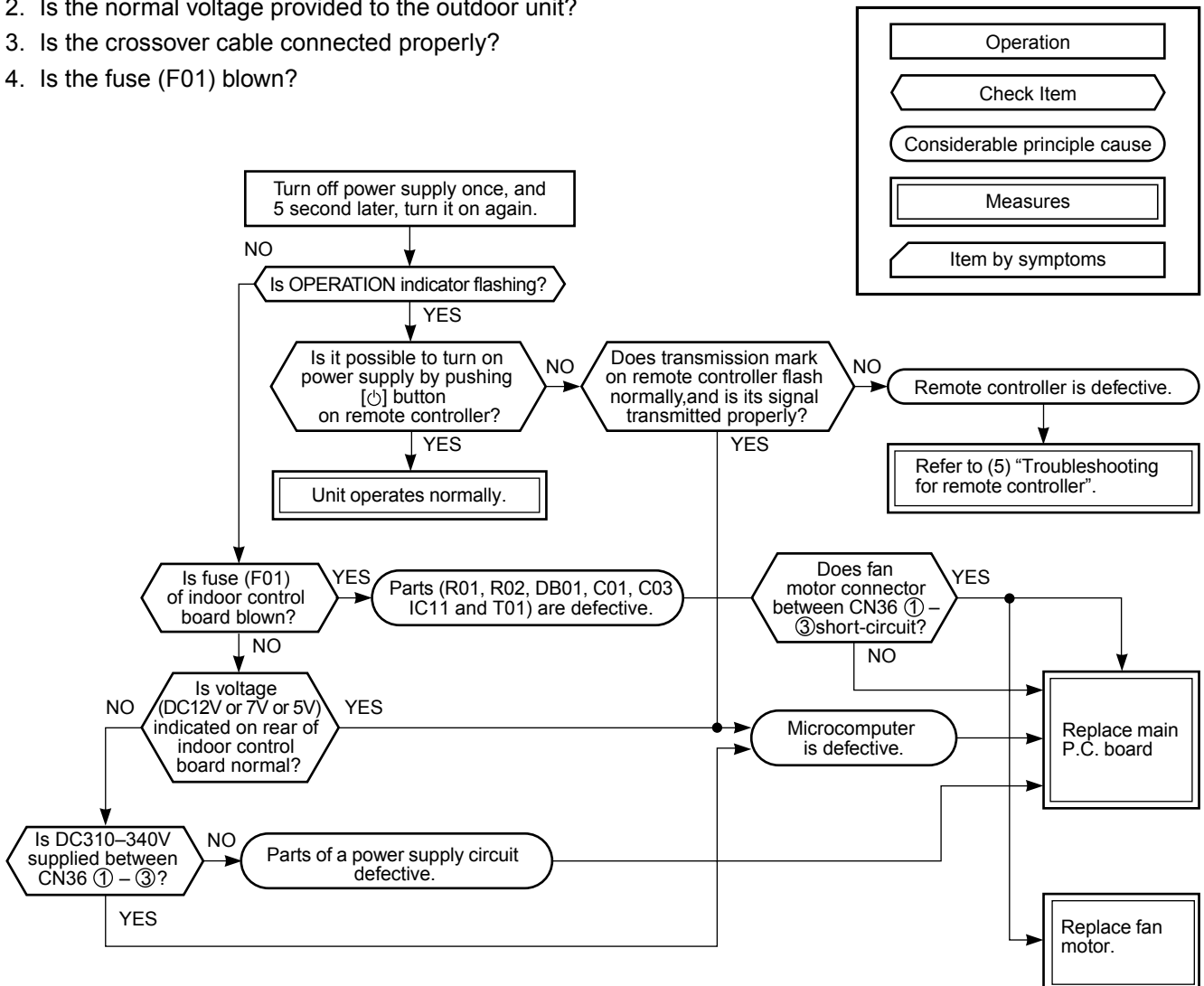

- Be sure to disconnect the motor connector CN36 after shut off the power supply, or it will be a cause of damage of the motor.

#### (2) Power is not turned on though Indoor P.C. board is replaced

##### <Confirmation procedure>

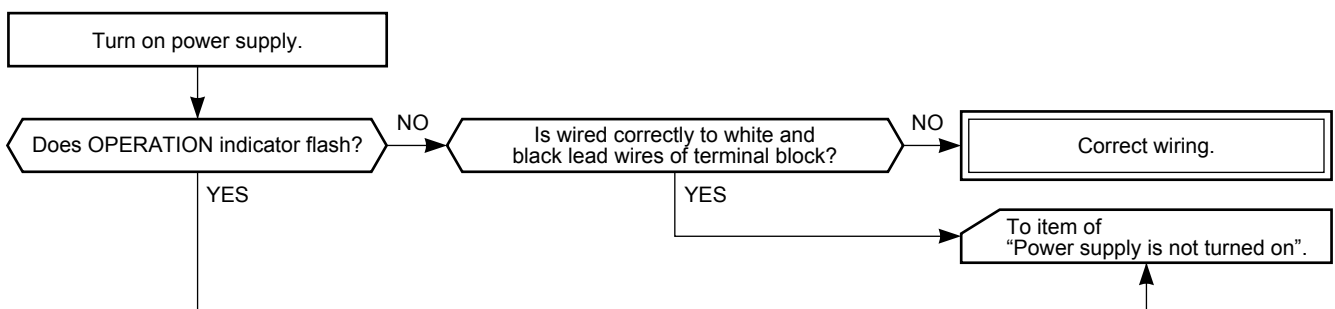



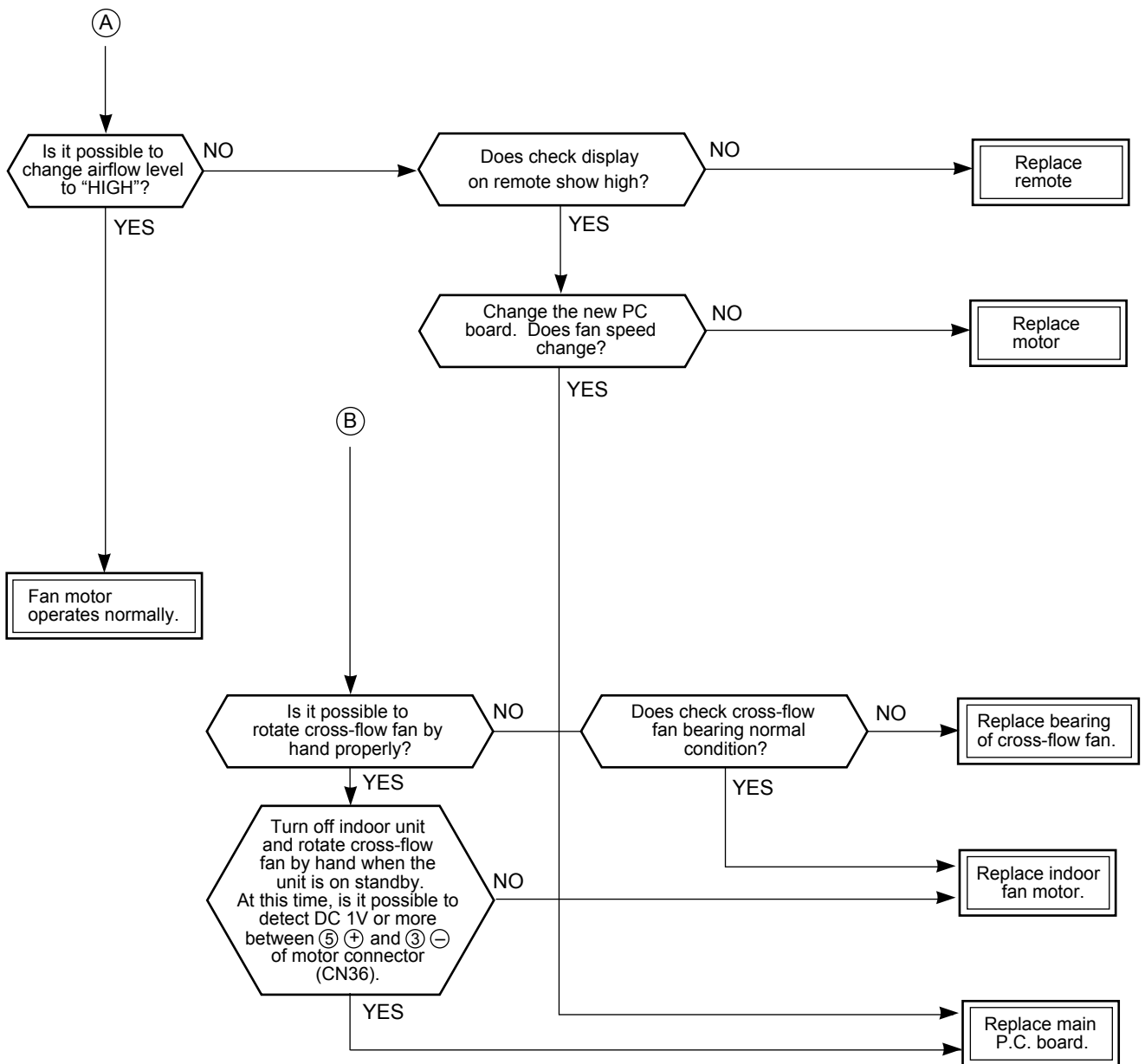

#### (4) Indoor fan motor automatically starts to rotate by turning on power supply

##### <Cause>

The IC is built in the indoor fan motor. Therefore the P.C. board is also mounted to inside of the motor.

If the P.C. board is soldered imperfectly or the IC is defective, the fan motor may automatically rotate by turning on power supply.

##### <Inspection procedure>

1. Remove the front panel. (Remove 4 screws.)
2. Remove the cover of the indoor unit controller. (remove 1 screw.)
3. Check DC voltage with CN36 connector while the fan motor is rotating.

##### NOTE :

- Do not disconnect the connector while the fan motor is rotating.
- Use a thin test rod.

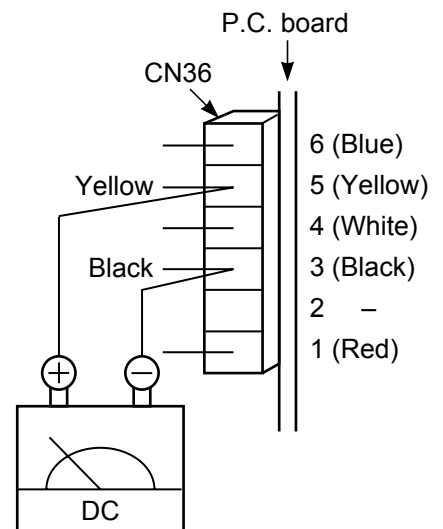
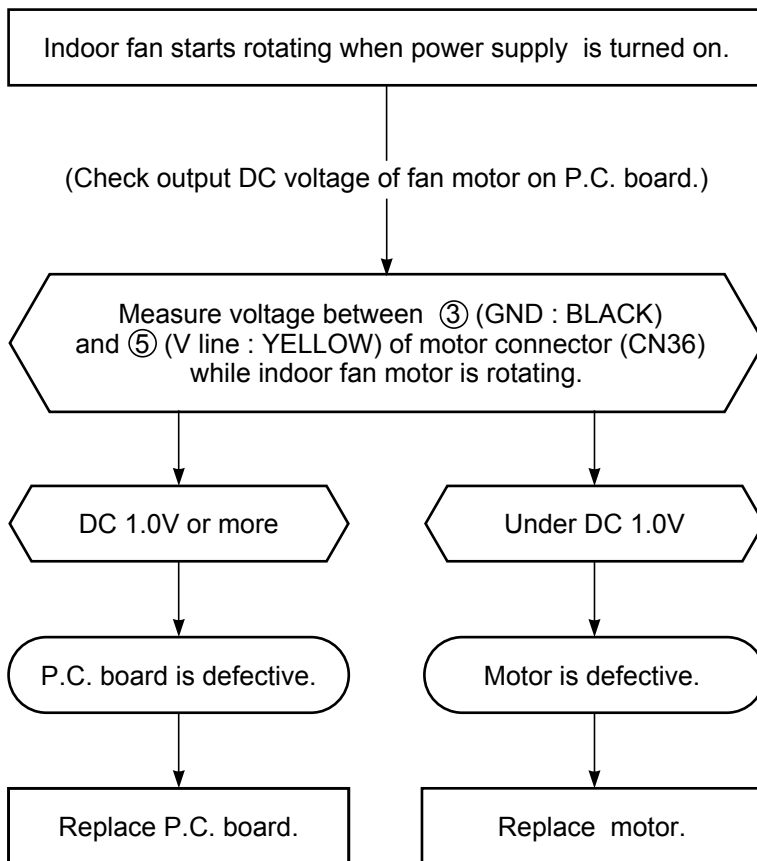

## (5) Troubleshooting for remote control

### <Primary check>

Check that A or B selected on the main unit is matched with A or B selected on the remote control.

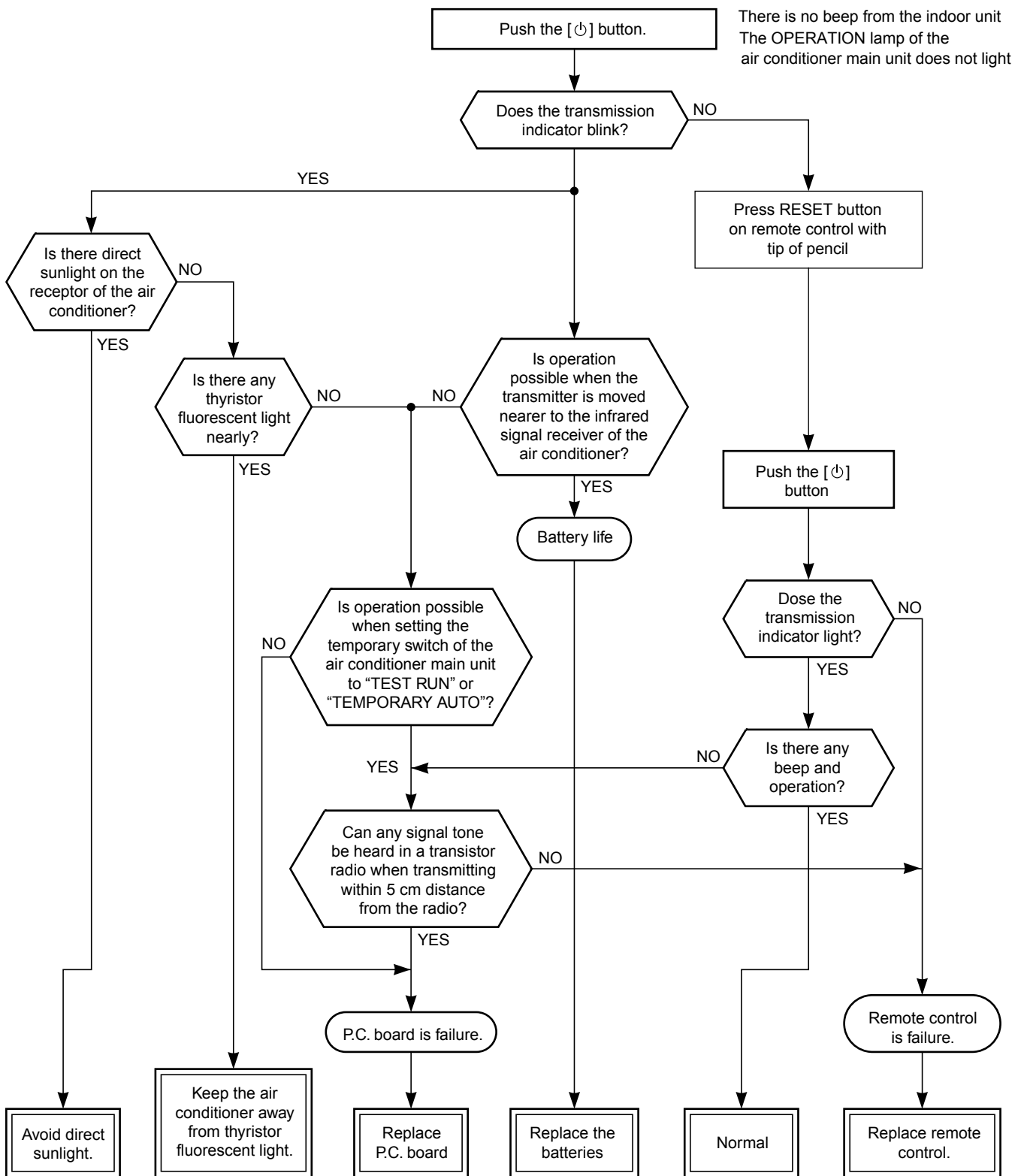



## 11-5-2. Wiring Failure (Interconnecting and Serial Signal Wire)

### (1) Outdoor unit does not operate

- 1) Is the voltage between ② and ③ of the indoor terminal block varied?

Confirm that transmission from indoor unit to outdoor unit is correctly performed based upon the following diagram.

#### NOTE:

- Measurement should be performed 2 minutes and 30 seconds after starting of the operation.
- Be sure to prepare a diode for judgment.

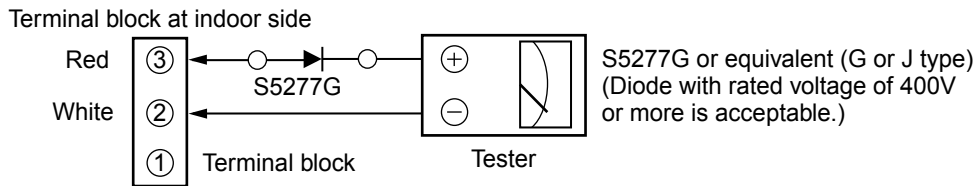

Normal time : Voltage swings between DC15 and 60V. .... Inverter Assembly check (11-7-1.)

Abnormal time : Voltage does not vary.

### (2) Outdoor unit stops in a little while after operation started

<Check procedure> Select phenomena described below.

- 1) The outdoor unit stops 10 to 20 minutes after operation started, and 10 minutes or more are required to restart the unit.

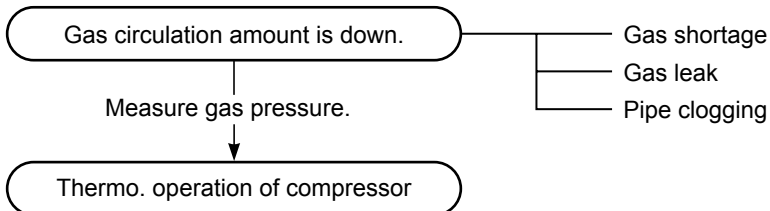

- 2) If the unit stops once, it does not operate until the power will be turned on again.

To item of Outdoor unit does not operate.

- 3) The outdoor unit stops 10 minutes to 1 hour after operation started, and an alarm is displayed. (Discharge temp. error check code 03, 1E Sensor temp. error check code 02, 1C)

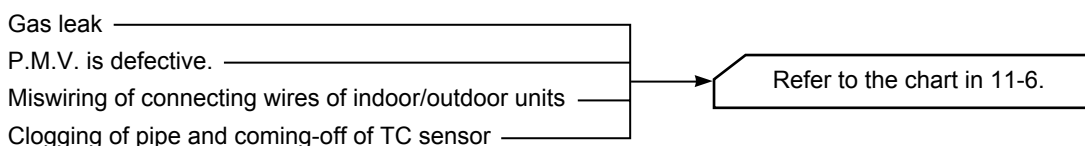

## 11-6. Check Code 1C (Miswiring in indoor/outdoor units) and 1E

<Check procedure>

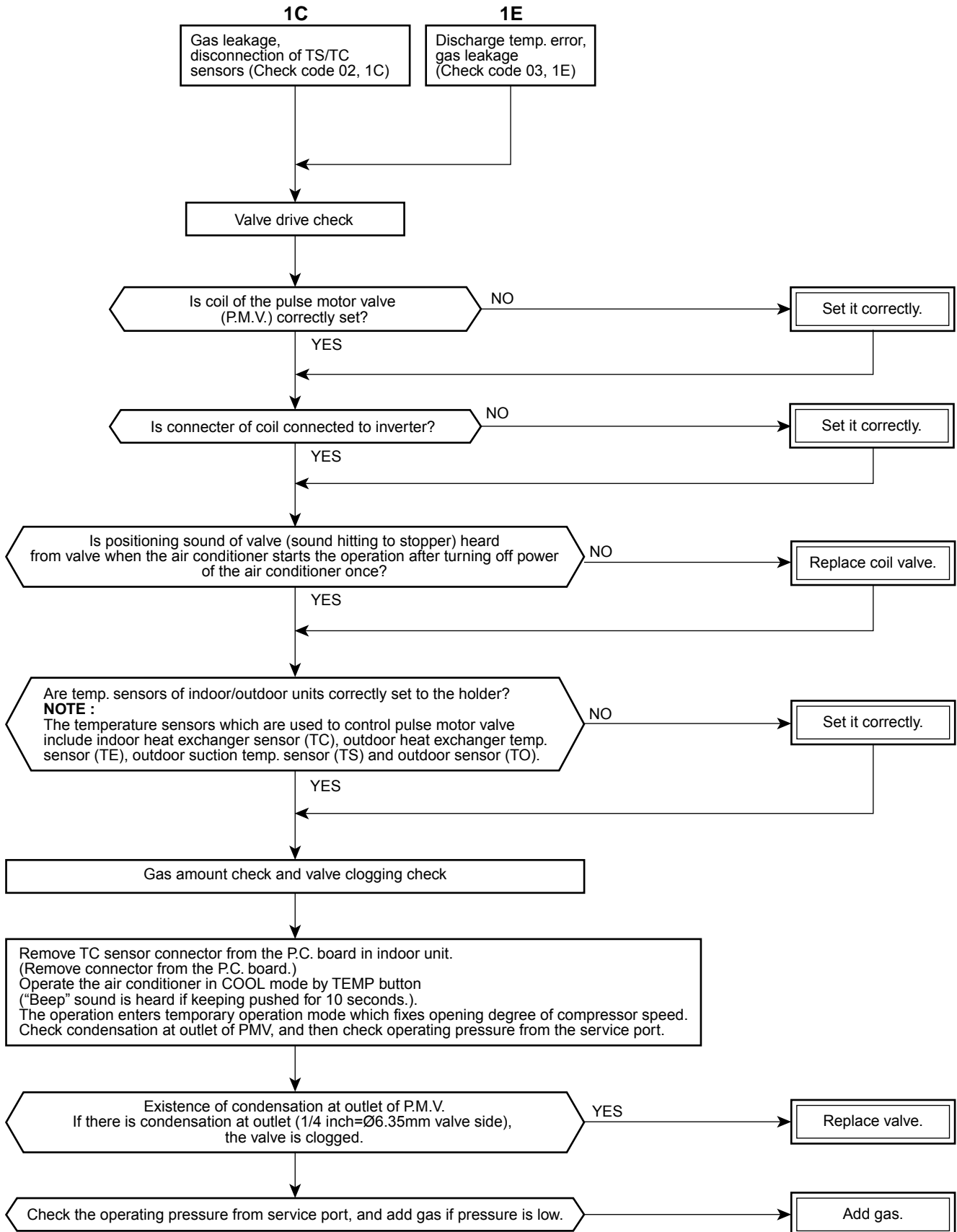

## 11-7. How to Diagnose Trouble in Outdoor Unit

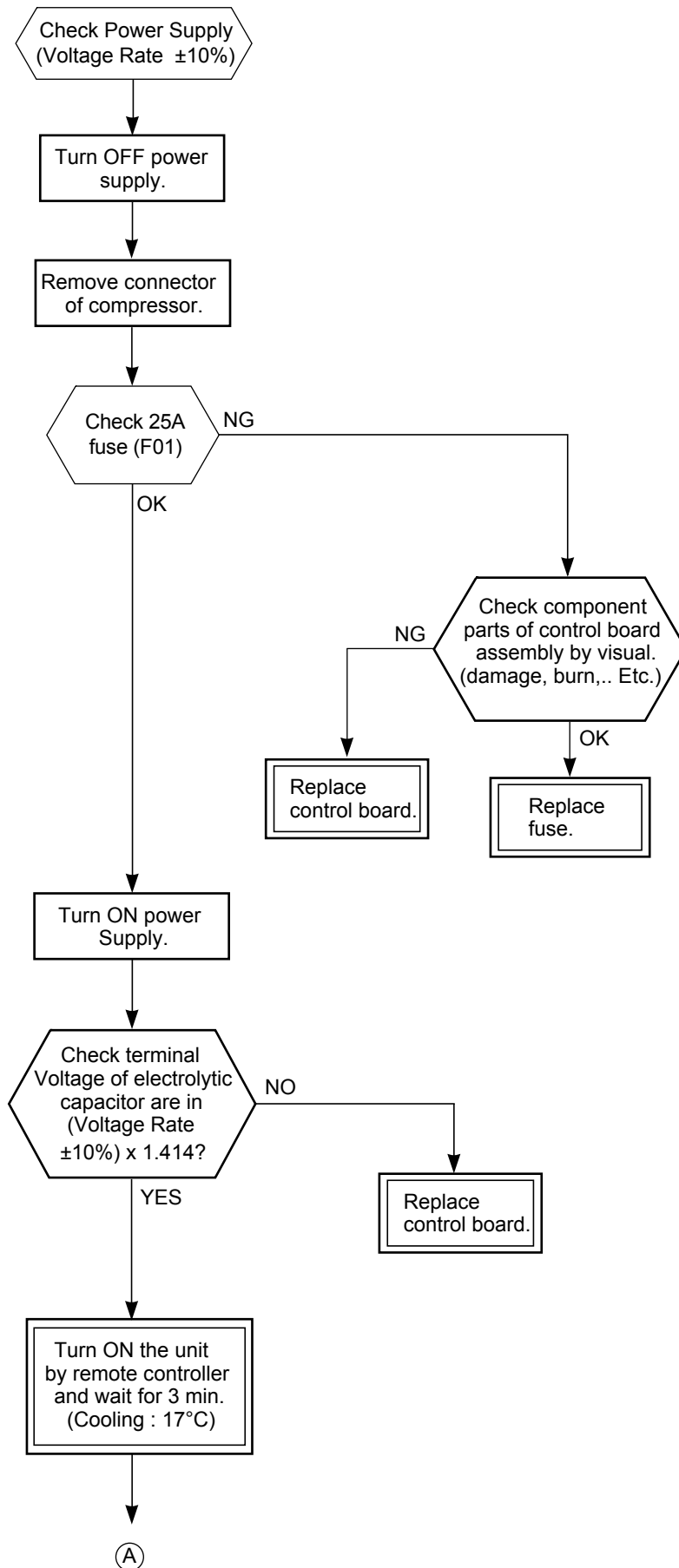

- Connect discharge resistance (approx. 100Ω, 40W) or soldering iron (plug) between +, – terminals of the electrolytic capacitor (500μF or 760μF)

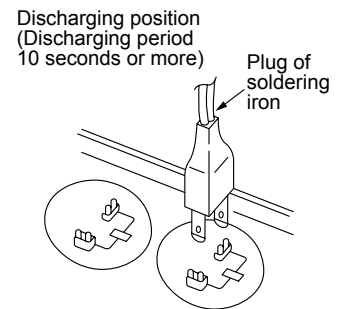

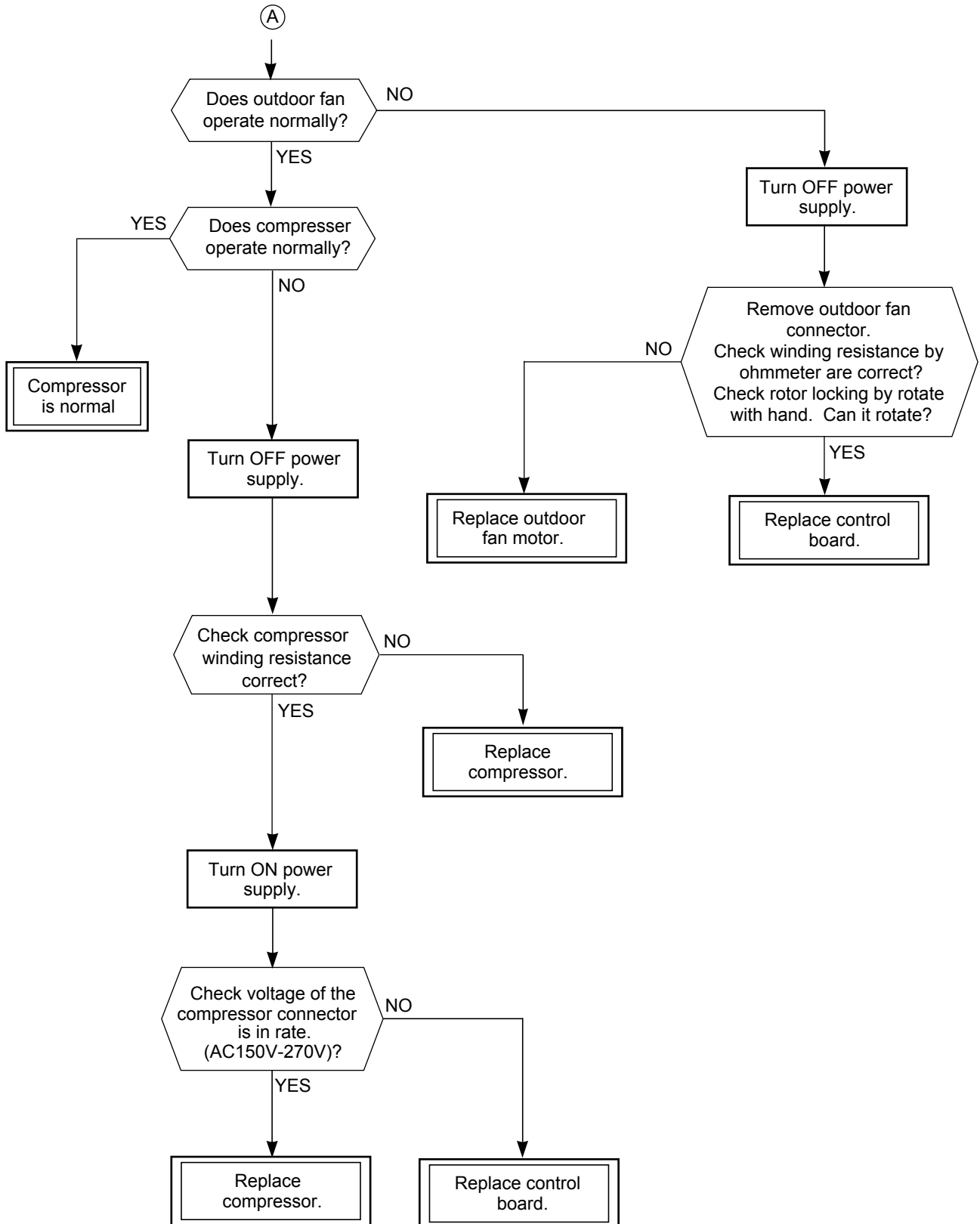

## **11-8. How to Check Simply the Main Parts**

### **8-1. How to Check the P.C. Board (Indoor Unit)**

#### **(1) Operating precautions**

- 1) When removing the front panel or the P.C. board, be sure to shut off the power supply breaker.
- 2) When removing the P.C. board, hold the edge of the P.C. board and do not apply force to the parts.
- 3) When connecting or disconnecting the connectors on the P.C. board, hold the whole housing. Do not pull at the lead wire.

#### **(2) Inspection procedures**

- 1) When a P.C. board is judged to be defective, check for disconnection, burning, or discoloration of the copper foil pattern or this P.C. board.
- 2) The P.C. board consists of the following 2 parts

##### **a. Main P.C. board part :**

DC power supply circuit, Indoor fan motor control circuit, CPU and peripheral circuits, buzzer, and Driving circuit of louver.

##### **b. Indication unit of infrared ray receiving infrared ray receiving circuit, LED :**

To check defect of the P.C. board, follow the procedure described below.

### (3) Check procedures

Table 11-8-1

No.	Procedure	Check points	Causes
1	Turn off the power supply breaker and remove the P.C. board assembly from electronic parts base. Remove the connecting cables from the terminal block.	Check whether or not the fuse (F01) or (F02) is blown.	Impulse voltage was applied or the indoor fan motor short-circuited.
2	Remove the connector of the motor and turn on the power supply breaker. If OPERATION indicator flashes (once per second), it is not necessary to check steps (1 to 5) in the right next column.	Check power supply voltage : 1. Between CN30 and CN31 (AC 220–240V) 2. Between ⊕ and ⊖ of C03 (DC 310–340V) 3. Between ⊕ and ⊖ of C117 (DC 15V) 4. Between 12V and GND 5. Between 5V and GND	1. The terminal block or the crossover cable is connected wrongly. 2. The capacitor (C01), line filter (L01), resistor (R03), or the diode (DB01) is defective. 3. T-01, D104, R104, IC14 and C112 are defective. 4. T-01, D103, Q102, IC15 and C117 are defective.
3	Push [⏻] button once to start the unit. (Do not set the mode to Fan Only or On-Timer operation.)	Check power supply voltage : 1. Between CN28 and CN31 (DC 15–60V)	IC51 and IC52 are defective.
4	Shorten the restart delay timer and start unit.	Check whether or not all indicators (OPERATION, TIMER, HI-POWER, ECO, Wi-Fi) are indicated for 3 seconds and they return to normal 3 seconds later.	The indicators are defective or the housing assembly (CN10) is defective.
5	Push [⏻] button once to start the unit, • Shorten the restart delay timer. • Set the operation mode to COOL. • Set the fan speed level to AUTO. • Set the preset temperature much lower than the room temperature. (The unit (compressor) operates continuously in the above condition.)	1. Check whether or not the compressor operates. 2. Check whether or not the OPERATION indicator flashes.	1. The temperature of the indoor heat exchanger is extremely low. 2. The connection of the heat exchanger sensor is loose. (The connector is disconnected.) (CN62) 3. The heat exchanger sensor and the P.C. board are defective. (Refer to Table 11-8-1.) 4. The main P.C. board is defective.
6	If the above condition (No. 5) still continues, start the unit in the following condition. • Set the operation mode to HEAT. • Set the preset temperature much higher than room temperature.	1. Check whether or not the compressor operates. 2. Check whether or not the OPERATION indicator flashes.	1. The temperature of the indoor heat exchanger is extremely high. 2. The connection of the heat exchanger sensor short-circuited. (CN62) 3. The heat exchanger sensor and the P.C. board are defective. (Refer to Table 11-4-1.) 4. The main P.C. board is defective
7	Connect the motor connector to the motor and turn on the power supply. Start the unit the following condition. • Set the fan speed level to HIGH. (The unit (compressor) operates continuously in the above condition in No. 5.)	1. Check it is impossible to detect the voltage (DC 15V) between 3 and 4 of the motor terminals. 2. The motor does not operate or the fan motor does not rotate with high speed. (But it is possible to receive the signal from the remote controller.) 3. The motor rotates but vibrates strongly.	1. The indoor fan motor is defective. (Protected operation of P.C. board.) 2. The P.C. board is defective. 3. The connection of the motor connector is loose.

# 11-8-2. P.C . Board Layout

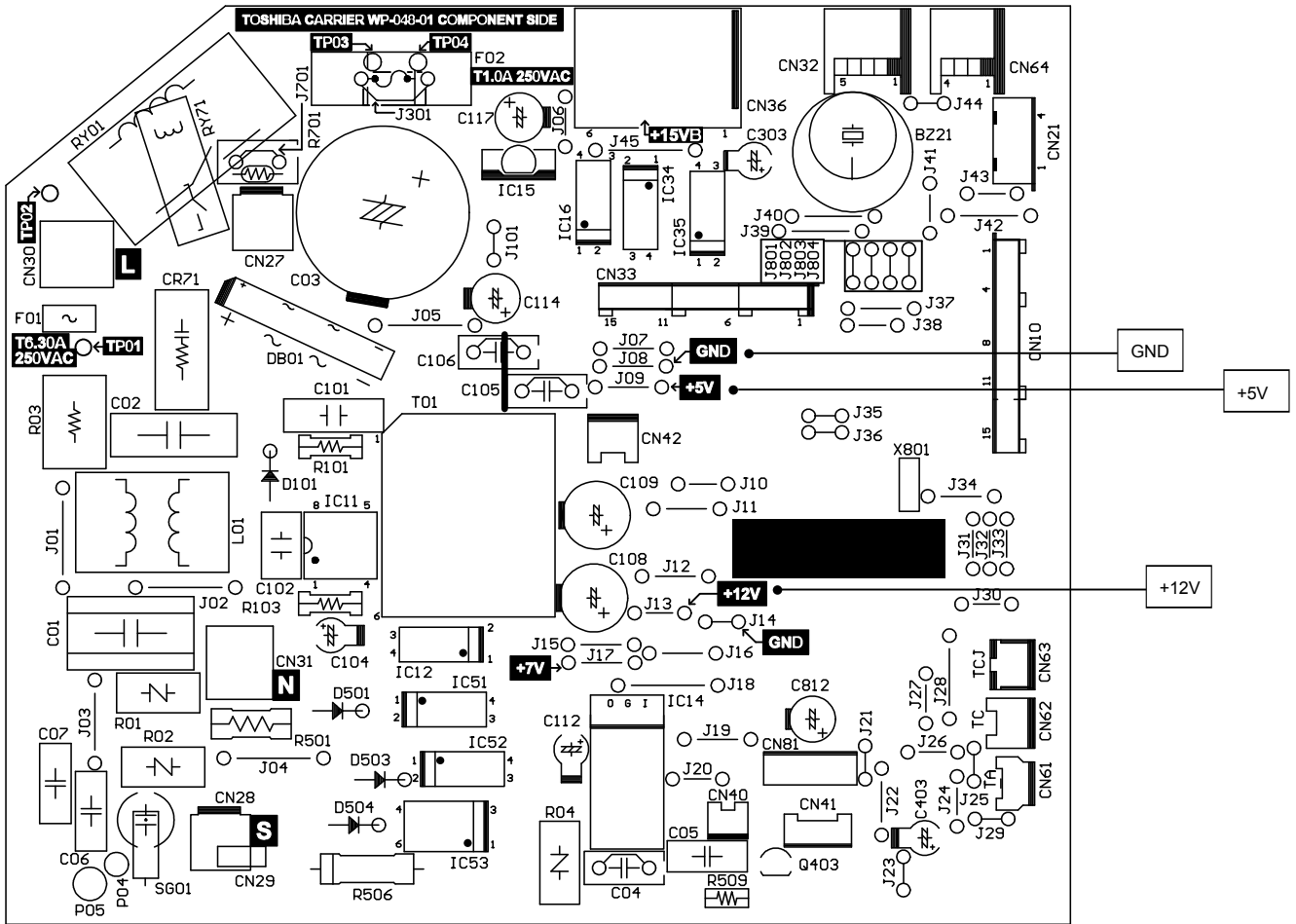

[1] Sensor characteristic table

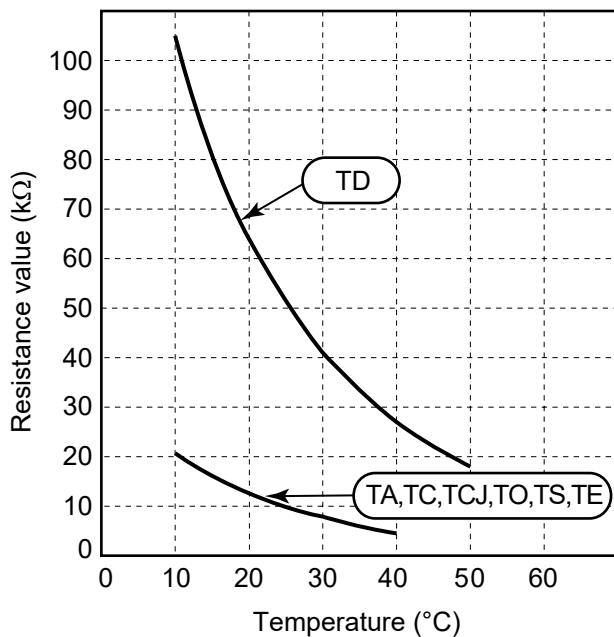

- TD : Discharge temp. sensor
- TA : Room temp. sensor
- TC, TCJ : Heat exchanger temp. sensor
- TO : Outdoor temp. sensor
- TS : Suction temp. sensor
- TE : Outdoor heat exchanger temp sensor

### 11-8-3. Indoor Unit (Other Parts)

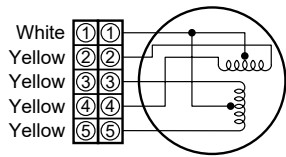
No.	Part name	Checking procedure																					
1	Room temp. (TA) sensor Heat exchanger (TC) sensor Heat exchanger (TCJ) sensor	Disconnect the connector and measure the resistance value with tester. (Normal temp.) <table border="1"> <thead> <tr> <th colspan="2">Temperature</th> <th>10°C</th> <th>20°C</th> <th>25°C</th> <th>30°C</th> <th>40°C</th> </tr> </thead> <tbody> <tr> <th>Sensor</th> <th></th> <td></td> <td></td> <td></td> <td></td> <td></td> </tr> <tr> <td>TA, TC, TCJ (kΩ)</td> <td></td> <td>20.7</td> <td>12.6</td> <td>10.0</td> <td>7.9</td> <td>4.5</td> </tr> </tbody> </table>	Temperature		10°C	20°C	25°C	30°C	40°C	Sensor							TA, TC, TCJ (kΩ)		20.7	12.6	10.0	7.9	4.5
Temperature		10°C	20°C	25°C	30°C	40°C																	
Sensor																							
TA, TC, TCJ (kΩ)		20.7	12.6	10.0	7.9	4.5																	
2	Remote controller	Refer to 11-5-1. (5).																					
3	Louver motor MP24Z3N	Measure the resistance value of each winding coil by using the tester. (Under normal temp. 25°C)  <table border="1"> <thead> <tr> <th>Position</th> <th>Resistance value</th> </tr> </thead> <tbody> <tr> <td>1 to 2</td> <td rowspan="5">250 ± 17Ω</td> </tr> <tr> <td>1 to 3</td> </tr> <tr> <td>1 to 4</td> </tr> <tr> <td>1 to 5</td> </tr> <tr> <td></td> </tr> </tbody> </table> <p style="text-align: right;">at 25°C</p>	Position	Resistance value	1 to 2	250 ± 17Ω	1 to 3	1 to 4	1 to 5														
Position	Resistance value																						
1 to 2	250 ± 17Ω																						
1 to 3																							
1 to 4																							
1 to 5																							
4	Indoor fan motor ICF-340-41-1	Refer to 11-5-1. (3) and (4).																					

### 11-8-4. Outdoor Unit

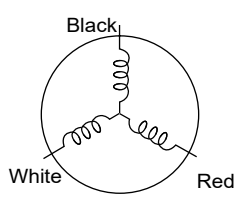
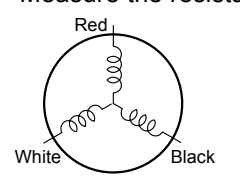
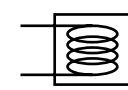
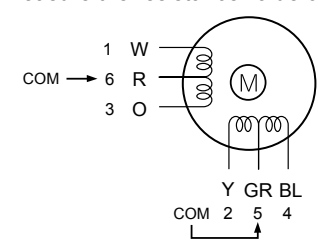
1	Compressor RAS-10J2AVSG-TR, TR1 Model : KSK75D43UEZA  RAS-13J2AVSG-TR, TR1 Model : KSK89D53UFZ  RAS-18J2AVSG-TR Model : KTN130D30UFZ	Measure the resistance value of each winding by using the tester.  <table border="1"> <thead> <tr> <th rowspan="2">Position</th> <th colspan="3">Resistance value</th> </tr> <tr> <th>KSK75D43UEZA</th> <th>KSK89D53UFZ</th> <th>KTN130D30UFZ</th> </tr> </thead> <tbody> <tr> <td>Red - White</td> <td rowspan="3">2.18Ω</td> <td rowspan="3">2.35Ω</td> <td rowspan="3">1.02Ω</td> </tr> <tr> <td>White - Black</td> </tr> <tr> <td>Black - Red</td> </tr> </tbody> </table> <p style="text-align: right;">at 20°C</p>	Position	Resistance value			KSK75D43UEZA	KSK89D53UFZ	KTN130D30UFZ	Red - White	2.18Ω	2.35Ω	1.02Ω	White - Black	Black - Red															
Position	Resistance value																													
	KSK75D43UEZA	KSK89D53UFZ	KTN130D30UFZ																											
Red - White	2.18Ω	2.35Ω	1.02Ω																											
White - Black																														
Black - Red																														
2	Fan motor	Measure the resistance value of winding by using the tester.  <table border="1"> <thead> <tr> <th>Position</th> <th>Resistance value</th> </tr> </thead> <tbody> <tr> <td></td> <td>WDF-340-A43-1</td> </tr> <tr> <td>Red - White</td> <td rowspan="3">33.7 ± 1.7Ω</td> </tr> <tr> <td>White - Black</td> </tr> <tr> <td>Black - Red</td> </tr> </tbody> </table> <p style="text-align: right;">at 20°C</p>	Position	Resistance value		WDF-340-A43-1	Red - White	33.7 ± 1.7Ω	White - Black	Black - Red																				
Position	Resistance value																													
	WDF-340-A43-1																													
Red - White	33.7 ± 1.7Ω																													
White - Black																														
Black - Red																														
3	4-Way valve coil	Measure the resistance value of winding by using the tester.  <table border="1"> <tbody> <tr> <td>RAS-10, 18</td> <td>Model : SQ-A2522G-000352</td> <td>Resistance value : 2210 ± 221Ω</td> </tr> <tr> <td>RAS-13</td> <td>Model : DXQ-939</td> <td>Resistance value : 1450 ± 150Ω</td> </tr> </tbody> </table> <p style="text-align: right;">at 20°C</p>	RAS-10, 18	Model : SQ-A2522G-000352	Resistance value : 2210 ± 221Ω	RAS-13	Model : DXQ-939	Resistance value : 1450 ± 150Ω																						
RAS-10, 18	Model : SQ-A2522G-000352	Resistance value : 2210 ± 221Ω																												
RAS-13	Model : DXQ-939	Resistance value : 1450 ± 150Ω																												
4	Pulse Modulating Valve (PMV) coil Model : PQ-M10012-000313	Measure the resistance value of winding by using the tester.  <table border="1"> <thead> <tr> <th>Position</th> <th>Resistance value</th> </tr> </thead> <tbody> <tr> <td>Red - White</td> <td>42 to 50Ω</td> </tr> <tr> <td>Red - Orange</td> <td>42 to 50Ω</td> </tr> <tr> <td>Gray - Yellow</td> <td>42 to 50Ω</td> </tr> <tr> <td>Gray - Blue</td> <td>42 to 50Ω</td> </tr> </tbody> </table> <p style="text-align: right;">at 20°C</p>	Position	Resistance value	Red - White	42 to 50Ω	Red - Orange	42 to 50Ω	Gray - Yellow	42 to 50Ω	Gray - Blue	42 to 50Ω																		
Position	Resistance value																													
Red - White	42 to 50Ω																													
Red - Orange	42 to 50Ω																													
Gray - Yellow	42 to 50Ω																													
Gray - Blue	42 to 50Ω																													
5	Outside air temp. sensor (TO) Discharge temp. sensor (TD) Suction temp. sensor (TS) Exchanger temp. sensor (TE)	Disconnect the connector, and measure resistance value with the tester. (Normal temperature) <table border="1"> <thead> <tr> <th colspan="2">Temperature</th> <th>10°C</th> <th>20°C</th> <th>30°C</th> <th>40°C</th> <th>50°C</th> </tr> </thead> <tbody> <tr> <th>Sensor</th> <th></th> <td></td> <td></td> <td></td> <td></td> <td></td> </tr> <tr> <td>TD (kΩ)</td> <td></td> <td>105</td> <td>64</td> <td>41</td> <td>27</td> <td>18</td> </tr> <tr> <td>TO, TS, TE (kΩ)</td> <td></td> <td>20.7</td> <td>12.6</td> <td>7.9</td> <td>4.5</td> <td>3.4</td> </tr> </tbody> </table>	Temperature		10°C	20°C	30°C	40°C	50°C	Sensor							TD (kΩ)		105	64	41	27	18	TO, TS, TE (kΩ)		20.7	12.6	7.9	4.5	3.4
Temperature		10°C	20°C	30°C	40°C	50°C																								
Sensor																														
TD (kΩ)		105	64	41	27	18																								
TO, TS, TE (kΩ)		20.7	12.6	7.9	4.5	3.4																								

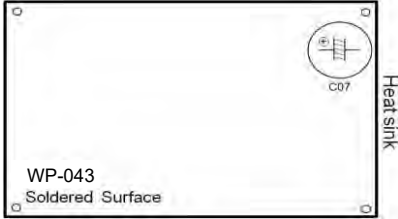
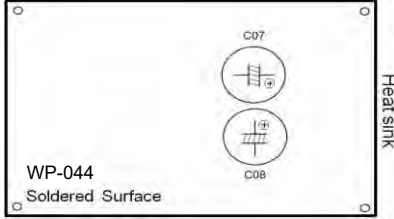
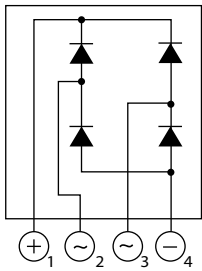
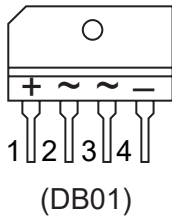

11-8-5. Checking Method for Each Part

No.	Part name	Checking procedure															
1	Electrolytic capacitor	<p>1. Turn OFF the power supply breaker.                  2. Discharge all three capacitors completely.                  3. Check that safety valve at the bottom of capacitor is not broken.                  4. Check that vessel is not swollen or exploded.                  5. Check that electrolytic liquid does not blow off.                  6. Check that the normal charging characteristics are show in continuity test by the tester.</p> <p><b>RAS-10, 13J2AVSG-TR, TR1</b></p>  <p>C07 → 760μF/ 450V</p> <p><b>RAS-18J2AVSG-TR</b></p>  <p>C09, C10 → 760μF/400V</p> <div style="border: 1px solid black; padding: 5px; width: fit-content; margin-top: 10px;"> <p><b>Case that product is good</b></p> <p>Pointer swings once, and returns slowly. When performing test once again under another polarity, the pointer should return.</p> </div>															
2	Converter module	<p>1. Turn OFF the power supply breaker.                  2. Discharge all three capacitors completely.                  3. Check that the normal rectification characteristics are shown in continuity test by the tester.</p> <div style="display: flex; justify-content: space-around; align-items: center;">   </div> <p style="text-align: center;">(DB01)</p> <p style="text-align: center;">Diode check</p> <table border="1" style="margin-left: auto; margin-right: auto;"> <thead> <tr> <th colspan="2">Tester rod</th> <th>Resistance value in good product</th> </tr> </thead> <tbody> <tr> <td>⊕<sub>1</sub></td> <td>⊖<sub>4</sub></td> <td rowspan="4" style="text-align: center; vertical-align: middle;">50kΩ or more (0Ω in trouble)</td> </tr> <tr> <td>⊖<sub>2</sub></td> <td>⊖<sub>4</sub></td> </tr> <tr> <td>⊖<sub>3</sub></td> <td>⊖<sub>4</sub></td> </tr> <tr> <td>⊕<sub>1</sub></td> <td>⊖<sub>2</sub></td> </tr> <tr> <td>⊕<sub>1</sub></td> <td>⊖<sub>3</sub></td> <td></td> </tr> </tbody> </table>	Tester rod		Resistance value in good product	⊕ <sub>1</sub>	⊖ <sub>4</sub>	50kΩ or more (0Ω in trouble)	⊖ <sub>2</sub>	⊖ <sub>4</sub>	⊖ <sub>3</sub>	⊖ <sub>4</sub>	⊕ <sub>1</sub>	⊖ <sub>2</sub>	⊕ <sub>1</sub>	⊖ <sub>3</sub>	
Tester rod		Resistance value in good product															
⊕ <sub>1</sub>	⊖ <sub>4</sub>	50kΩ or more (0Ω in trouble)															
⊖ <sub>2</sub>	⊖ <sub>4</sub>																
⊖ <sub>3</sub>	⊖ <sub>4</sub>																
⊕ <sub>1</sub>	⊖ <sub>2</sub>																
⊕ <sub>1</sub>	⊖ <sub>3</sub>																

## 12. HOW TO REPLACE THE MAIN PARTS

### WARNING

- Since high voltages pass through the electrical parts, turn off the power without fail before proceeding with the repairs.

Electric shocks may occur if the power plug is not disconnected.

- After the repairs have been completed (after the front panel and cabinet have been installed), perform a test run, and check for smoking, unusual sounds and other abnormalities.

If this check is omitted, a fire and/or electric shocks may occur.

Before proceeding with the test run, install the front panel and cabinet.

- Ensure that the following steps are taken when doing repairs on the refrigerating cycle.

1. Do not allow any naked flames in the surrounding area.

If a gas stove or other appliance is being used, extinguish the flames before proceeding.

If the flames are not extinguished, they may ignite any oil mixed with the refrigerant gas.

2. Do not use welding equipment in an airtight room.

Carbon monoxide poisoning may result if the room is not properly ventilated.

3. Do not bring welding equipment near flammable objects.

Flames from the equipment may cause the flammable objects to catch fire.

- **If keeping the power on is absolutely unavoidable while doing a job such as inspecting the circuitry, wear rubber gloves to avoid contact with the live parts.**





Electric shocks may be received if the live parts are touched.



High-voltage circuits are contained inside this unit.

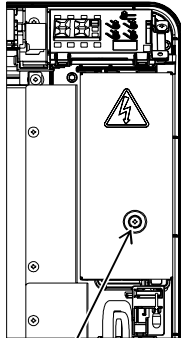

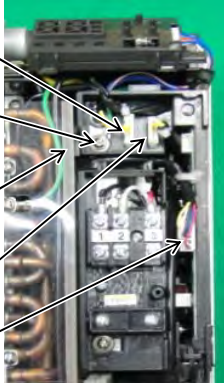
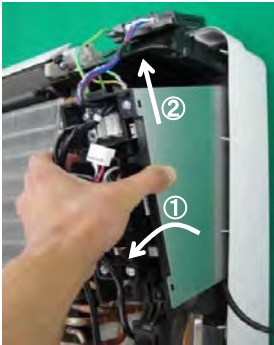
Proceed very carefully when conducting checks since directly touching the parts on the control circuit board may result in electric shocks.



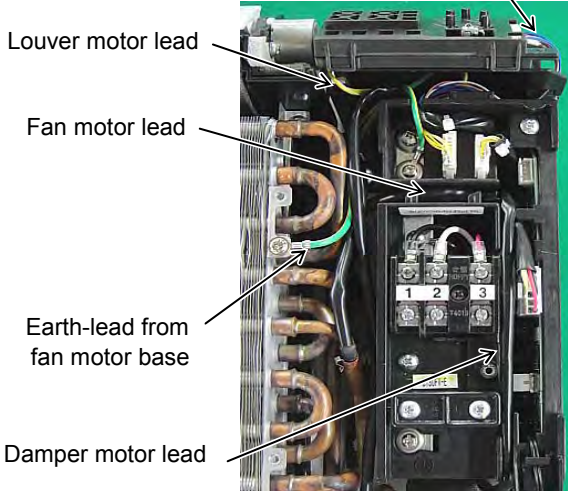
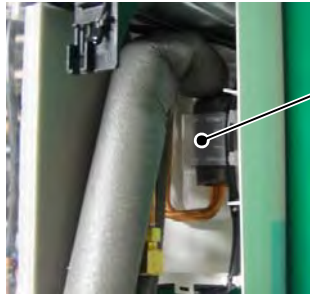
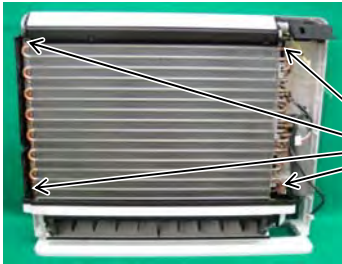
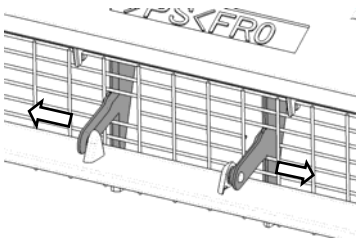

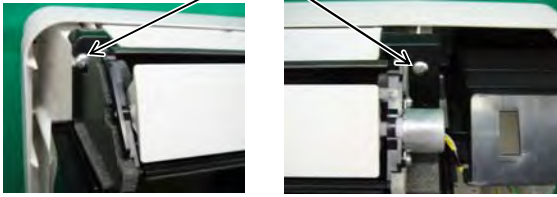

### 12.1 Indoor Unit

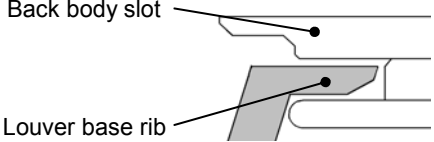
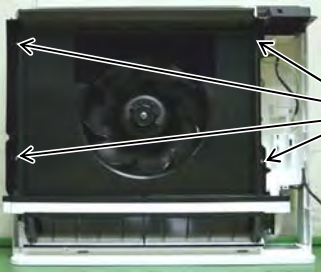
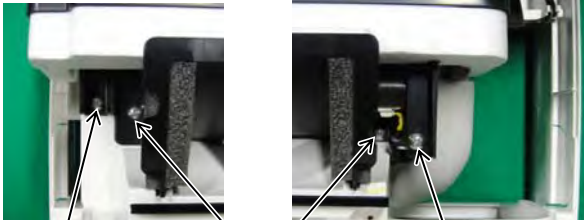

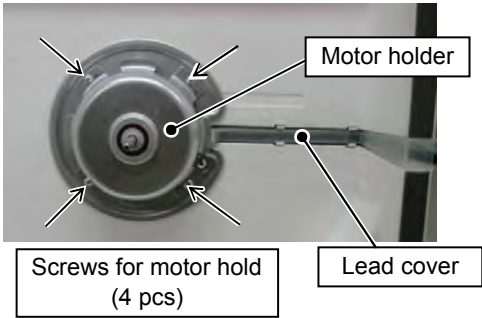
No.	Part name	Procedure	Remarks
①	Front panel	<p>1) Stop operation of the air conditioner and turn off the main power supply.</p> <p>2) Grip the air inlet grille by two hands at the handle positions.</p> <p>3) Pull the air inlet grille as the arrow direction and remove the rope from the hook of front panel.</p> <p>4) Remove screws for front panel. (4 pcs)</p>	<p>Air inlet grille</p> <p>Hook of front panel</p> <p>Rope</p> <p>4) Screws of front panel (4 pcs)</p>

No.	Part name	Procedure	Remarks
②	Electrical parts Box assembly (E-box)	<p>1) Remove screw for E-box cover.</p> <p>2) Remove screw for drain guide. (4 pcs)</p> <p>3) Remove screw for earth-lead.</p> <p>4) Remove screw for display base.</p> <p>5) Pull off the TC, TCJ sensor.</p> <p>6) Take off fan motor connector.</p> <p>7) Take off louver motor connector.</p> <p>8) Take off damper motor connector.</p> <p>9) Remove screw for earth-lead from fan motor base.</p> <p>10) Remove screw for E-box</p> <p>11) - ① Pull the upper part of the E-box.</p> <p>11) - ② Lift a E-box in the upward for take off from the hook.</p>	  <p>1) Screw for E-box cover</p> <p>4) The screw for display base</p>  <p>2) Screws for drain guide (4 pcs)</p> <p>3) Screw for earth-lead</p> <p>5) TCJ sensor</p> <p>5) TC sensor</p>  <p>7) Louver motor connector</p> <p>9) Screw for earth-lead from fan motor base</p> <p>10) Screw for E-box</p> <p>8) Damper motor connector</p> <p>6) Fan motor connector</p>   <p>Hook for locking E-box</p>

No.	Part name	Procedure	Remarks
②	Electrical parts Box assembly (E-box)	<How to arrange the lead> Shown in the picture.	 <p>Display unit lead</p> <p>Louver motor lead</p> <p>Fan motor lead</p> <p>Earth-lead from fan motor base</p> <p>Damper motor lead</p>
③	Heat exchanger (Refrigerant cycle assembly)	<p>1) Take off the pipe holder.</p> <p>2) Remove screws for heat exchanger. (4 pcs)</p>	 <p>Pipe holder</p>  <p>Screws for heat exchanger (4 pcs)</p>
④	Horizontal 1) louver	Open a horizontal louver outward and stretch the arm of louver base same as the direction in the picture.	 

No.	Part name	Procedure	Remarks
⑤	Louver base assembly	<p>1) Remove screws for louver base. (2 pcs)</p> <p>2) - ① Pull the upper part of the louver base to upward.</p> <p>2) - ② Take off the louver base by pull out in the front direction.</p> <p>&lt;Attention for louver base assemble&gt; Insert the rib of the louver base into the slot of back body same as the picture.</p>	<p>Screws for louver base (2 pcs)</p>    <p>Back body slot</p> <p>Louver base rib</p> 
⑥	Bell mouth	1) Remove screws for bell mouth. (4 pcs)	 <p>Screws for bell mouth (4 pcs)</p>
⑦	Drain pan and damper base	<p>1) Remove screws for drain pan. (2 pcs)</p> <p>2) Remove screws for damper base. (2 pcs)</p>	 <p>Screws for damper base (2 pcs)</p> <p>Screw for drain pan</p> <p>Screw for drain pan</p>

No.	Part name	Procedure	Remarks
⑧	Turbo fan	<p>1) Turn the flange nut (M10) in the counter-clockwise direction and take it off.</p> <p>2) Pull out the turbo fan from the fan motor shaft.</p> <p>&lt;Attention for turbo fan assemble&gt; The tightening torque of the flange nut is 5N·m.</p>	
⑨	Fan motor	<p>1) Remove screws for motor holder, and take off the motor holder.</p> <p>2) Take off the lead cover.</p> <p>&lt;Attention for motor holder assemble&gt; 1. Arrange the earth lead and fan motor lead. 2. Adjust the motor axis to the center of the motor holder then fix screws 4 pcs.</p>	   
⑩	Fan motor	<p>A method to take off a fan motor in a condition taking on a heat exchanger.</p> <p>1) Take off pipe holder and remove screws for heat exchanger. (refer to ③)</p> <p>2) Remove screws for the bell mouth. (refer to ⑥)</p>	 

No.	Part name	Procedure	Remarks
⑩	Fan motor	<p>3) Remove the flange nut and turbo fan. (refer to ⑧)</p> <p>4) Remove screws for motor holder and lead cover. (refer to ⑨)</p>	  

## 12-2. Microcomputer



No.	Part name	Procedure	Remarks
①	Common procedure	1) Turn the power supply off to stop the operation of air-conditioner. 2) Remove the front panel. • Remove the 2 fixing screws. 3) Remove the electrical part base.	Replace terminal block, microcomputer ass'y and the P.C. board ass'y.

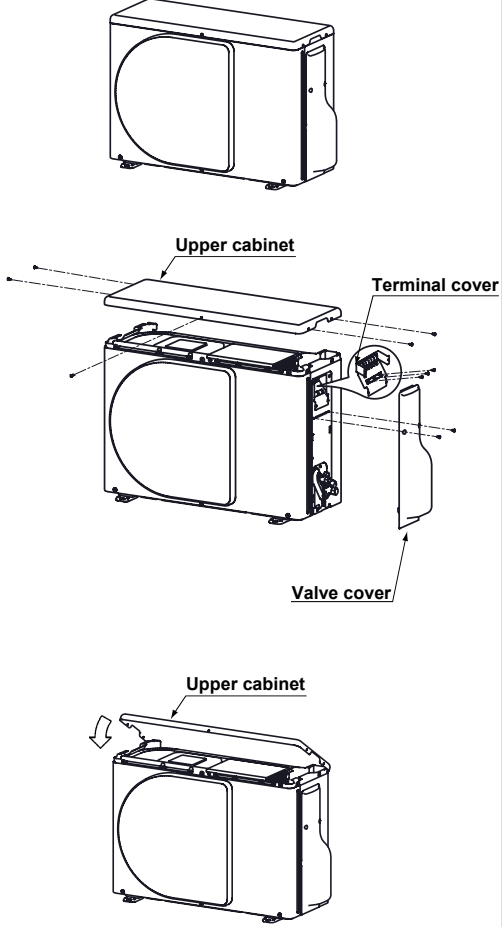

## 12-3. Outdoor unit (RAS-10, 13J2AVSG-TR, TR1)

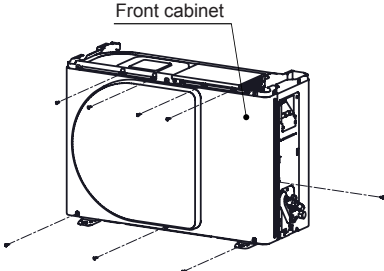
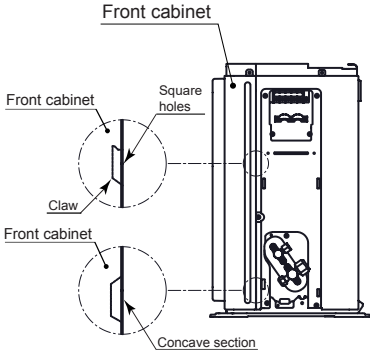
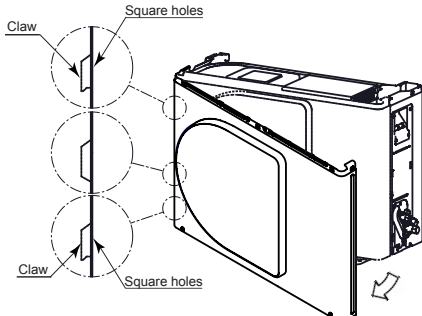
No.	Part name	Procedures	Remarks
①	Common procedure	<p><b>1. Detachment</b></p> <div style="border: 1px solid black; padding: 5px; margin-bottom: 10px;"> <p style="text-align: center;"><b>NOTE</b></p> <p><b>Wear gloves for this job. Otherwise, you may injure your hands on the parts, etc.</b></p> </div> <ol style="list-style-type: none"> <li>1) Stop operation of the air conditioner, and turn off the main switch of the breaker for air conditioner.</li> <li>2) Remove the valve cover. (ST2TØ4 × 10L 2 pcs.) <ul style="list-style-type: none"> <li>• After removing screw, remove the valve cover pulling it downward.</li> </ul> </li> <li>3) Remove cord clamp (ST2TØ4 × 14L 3 pcs.), and then remove connecting cable.</li> <li>4) Remove the upper cabinet. (ST2TØ4 × 10L 5 pcs.) <ul style="list-style-type: none"> <li>• After removing screws, remove the upper cabinet pulling it upward.</li> </ul> </li> </ol> <p><b>2. Attachment</b></p> <ol style="list-style-type: none"> <li>1) Attach the upper cabinet. (ST2TØ4 × 10L 5 pcs.)</li> <li>2) Perform cabling of connecting cable, and attach the cord clamp. <ul style="list-style-type: none"> <li>• Fix the cord clamp by tightening the screws (ST2TØ4 x 14L 3 pcs.), fitting concave parts of the cord clamp to each connecting cables.</li> </ul> </li> <li>3) Attach the valve cover. (ST2TØ4 x 10L 2 pcs.) <ul style="list-style-type: none"> <li>• Insert the upper part into the square hole of the side cabinet, set hook claws of the valve cover to square holes (at three positions) of the main unit, and attach it pushing upward,</li> </ul> </li> </ol>	 <p>The diagram illustrates the process of removing and reattaching the upper cabinet and valve cover of the outdoor unit. It shows three stages: 1) The complete outdoor unit. 2) The upper cabinet being lifted off the main unit, with the terminal cover and valve cover also shown being removed. 3) The upper cabinet being reattached to the main unit.</p>

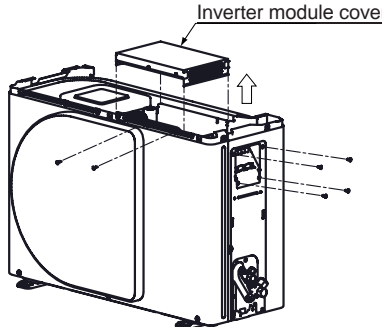
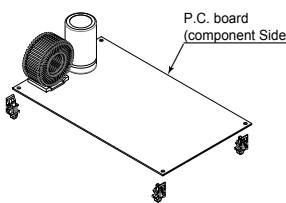
No.	Part name	Procedures	Remarks
②	Front cabinet	<p><b>1. Detachment</b></p> <ol style="list-style-type: none"> <li>1) Perform step 1 in ①.</li> <li>2) Remove the fixing screws (ST2TØ4 × 10L 2 pcs.) used to secure the front cabinet and inverter cover, the screws (ST2TØ4 × 10L 4 pcs.) used to secure the front cabinet at the bottom, and the fixing screws (ST2TØ4 × 10L 2 pcs.) used to secure the motor base.</li> </ol> <ul style="list-style-type: none"> <li>• The front cabinet is fitted into the side cabinet (left) at the front left side so pull up the top of the front cabinet to remove it.</li> </ul> <p><b>2. Attachment</b></p> <ol style="list-style-type: none"> <li>1) Insert the claw on the front left side into the side cabinet (left).</li> <li>2) Hook the bottom part of the front right side onto the concave section of the bottom plate. Insert the claw of the side cabinet (right) into the square hole in the front cabinet.</li> <li>3) Return the screws that were removed above to their original positions and attach them.</li> </ol>	 <p>Front cabinet</p>  <p>Front cabinet</p> <p>Front cabinet</p> <p>Square holes</p> <p>Claw</p> <p>Concave section</p>  <p>Claw</p> <p>Square holes</p> <p>Claw</p> <p>Square holes</p>

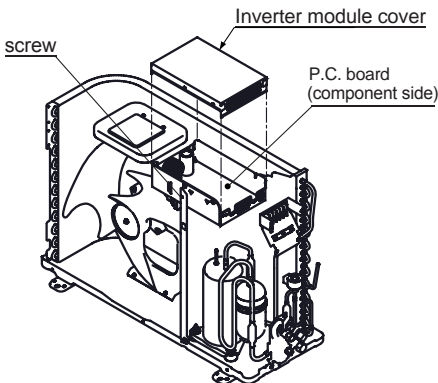
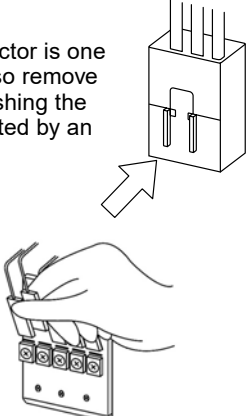
No.	Part name	Procedures	Remarks
③	Inverter assembly	<p>1) Perform work of item 1 in ①.</p> <p>2) Remove screw (ST2TØ4×10L 2 pcs.) of the upper part of the front cabinet.</p> <ul style="list-style-type: none"> <li>• Disconnect connectors all connector on P.C. board.</li> <li>• Take off P.C. board out from spacer under P.C. board.</li> <li>• If there is no space above the unit, perform work of 1 in ②.</li> </ul> <div style="border: 1px solid black; padding: 5px; margin: 10px 0;"> <p><b>Be careful to check the inverter because high-voltage circuit is incorporated in it.</b></p> </div> <p>3) Perform discharging by connecting ⊕, ⊖ polarity by discharging resistance (approx. 100Ω40W) or plug of soldering iron to ⊕, ⊖ terminals a of the C07 (printed “CAUTION HIGH VOLTAGE” is attached.) electrolytic capacitor (760μF) on P.C. board.</p> <div style="border: 1px solid black; padding: 5px; margin: 10px 0;"> <p><b>Be careful to discharge the capacitor because the electrolytic capacitor cannot naturally discharge and voltage remains according to trouble type in some cases.</b></p> </div> <div style="border: 1px solid black; padding: 5px; margin: 10px 0; text-align: center;"> <p><b>NOTE</b></p> <p><b>This capacitor is one with mass capacity. Therefore, it is dangerous that a large spark generates if short-circuiting between ⊕, ⊖</b></p> </div> <p>4) Remove screw (ST2TØ4 x 10L 4pcs.) fixing the terminal part of inverter box to the main body.</p> <p>5) Remove the front cabinet by performing step 1 in ② , and remove the fixing screws (ST2TØ4 x 10L) for securing the main body and inverter box.</p> <p>6) Disconnect connectors of various lead wires.</p> <div style="border: 1px solid black; padding: 5px; margin: 10px 0;"> <p><b>Requirement</b></p> <p><b>As each connector has a lock mechanism, avoid to remove the connector by holding the lead wire, but by holding the connector.</b></p> </div>	 <p style="text-align: center;">Inverter module cover</p>  <p style="text-align: center;">P.C. board (component Side)</p> <p>Discharging position (Discharging period 10 seconds or more)</p>  <p style="text-align: right;">Plug of soldering iron</p>  <p style="text-align: center;">Inverter module cover</p> <p style="text-align: left;">screw</p> <p style="text-align: right;">P.C. board (component side)</p> <p>The connector is one with lock, so remove it while pushing the part indicated by an arrow.</p>  <p>Be sure to remove the connector by holding the connector, not by pulling the lead wire.</p>

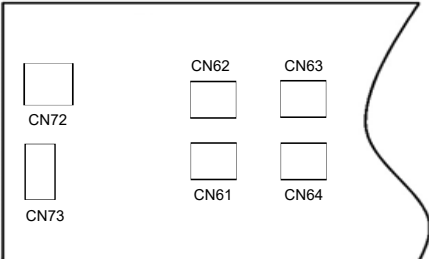
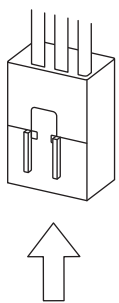
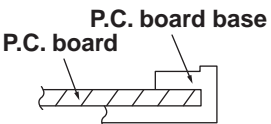
No.	Part name	Procedures	Remarks
④	Control board assembly	<p>1. Disconnect the leads and connectors connected to the other parts from the control board assembly.</p> <p>1) Leads</p> <ul style="list-style-type: none"> <li>• 3 leads (black, white, orange) connected to terminal block.</li> <li>• Lead connected to compressor : Disconnect the connector (3P).</li> </ul> <p>2) Connectors</p> <p>CN31 : Outdoor fan motor (3P: white)* (* : See Note)</p> <p>CN61 : TE sensor (2P: white) CN62 :TD sensor (3P: white)* CN63 : TO sensor (2P: white) CN64 : TS sensor (3P: white)* CN72 : 4-way valve (2P: yellow) CN73 : PMV (6P: white)</p> <div style="border: 1px solid black; padding: 5px; margin: 10px 0;"> <p style="text-align: center;"><b>NOTE</b></p> <p><b>These connectors have a disconnect prevention mechanism: as such, the lock on their housing must be released before they are disconnected.</b></p> </div> <p>2. Remove the control board assembly from the P.C. board base. (Remove the heat sink a control board assembly while keeping them screwed together.)</p> <div style="border: 1px solid black; padding: 5px; margin: 10px 0;"> <p style="text-align: center;"><b>NOTE</b></p> <p><b>Disengage the four claws of the P.C. board base, hold the heat sink, and lift to remove it.</b></p> </div> <p>3. Remove the two fixing screws used to secure the heat sink and control board assembly.</p> <p>4. Mount the new control board assembly.</p> <div style="border: 1px solid black; padding: 5px; margin: 10px 0;"> <p style="text-align: center;"><b>NOTE</b></p> <p><b>When mounting the new control board assembly, ensure that the P.C. board is inserted properly into the P.C. board support groove.</b></p> </div>	<div style="border: 1px solid black; padding: 10px; margin-bottom: 20px;">  </div> <p>CN31, CN61, CN62, CN64, CN63, CN72 and CN73 are connectors with locking mechanisms: as such, to disconnect them, they must be pressed in the direction of the arrow while pulling them out.</p> <div style="text-align: center; margin: 20px 0;">  </div> <div style="text-align: center;">  <p style="text-align: center;">P.C. board base P.C. board</p> </div>

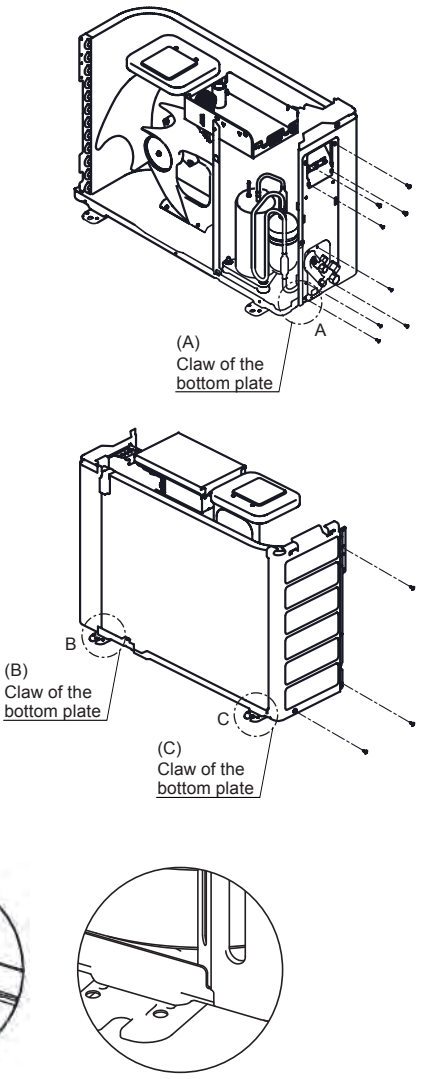
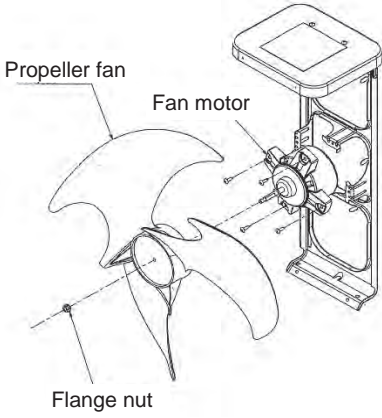
No.	Part name	Procedures	Remarks
⑤	Side cabinet	<p><b>1. Side cabinet (right)</b></p> <ol style="list-style-type: none"> <li>1) Perform step 1 in ② and all the steps in ③.</li> <li>2) Remove the fixing screw (ST2TØ4 × 10L 4 pcs.) used for securing the side cabinet to the bottom plate and valve fixing panel</li> </ol> <p><b>2. Side cabinet (left)</b></p> <ol style="list-style-type: none"> <li>1) Perform step 1 in ②.</li> <li>2) Remove the fixing screw (ST2TØ4 × 10L 1 pc.) used to secure the side cabinet (left) onto the heat exchanger.</li> <li>3) Remove the fixing screw (ST2TØ4 × 10L 2 pcs.) used for securing the side cabinet to the bottom plate and heat exchanger.</li> </ol>	
⑥	Fan motor	<ol style="list-style-type: none"> <li>1) Perform work of item 1 of ① and ②.</li> <li>2) Remove the flange nut fixing the fan motor and the propeller. <ul style="list-style-type: none"> <li>• Flange nut is loosened by turning clockwise. (To tighten the flange nut, turning counterclockwise.)</li> </ul> </li> <li>3) Remove the propeller fan.</li> <li>4) Disconnect the connector for fan motor from the inverter.</li> <li>5) Remove the fixing screws (4 pcs.) holding by hands so that the fan motor does not fall.</li> </ol> <p>* Precautions when assembling the fan motor Tighten the flange nut using a tightening torque of 4.9 N•m.</p>	

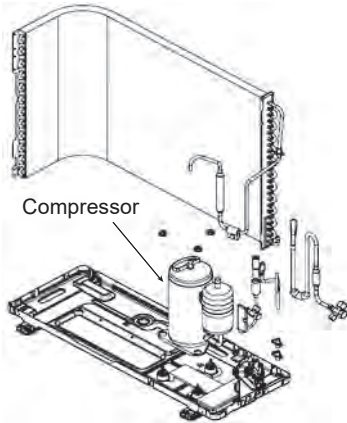
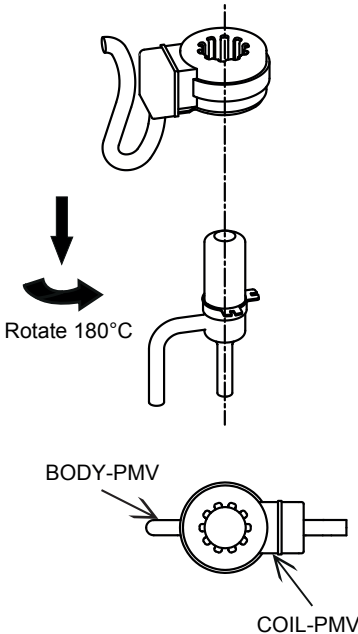
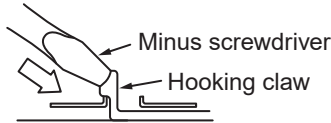
No.	Part name	Procedures	Remarks
⑦	Compressor	<ol style="list-style-type: none"> <li>1) Perform work of item 1 of ① and ②, ③, ④, ⑤.</li> <li>2) Extract refrigerant gas.</li> <li>3) Remove the partition board. (ST2TØ4 × 10L 3 pcs.)</li> <li>4) Remove the sound-insulation material.</li> <li>5) Remove terminal cover of the compressor, and disconnect lead wire of the compressor from the terminal.</li> <li>6) Remove pipe connected to the compressor with a burner.</li> <li>7) Remove the fixing screw of the bottom plate and heat exchanger. (ST2TØ4 × 10L 1 pc.)</li> <li>8) Remove the fixing screw of the bottom plate and valve fixing plate. (ST2TØ4 × 10L 1 pc.)</li> <li>9) Pull upward the refrigeration cycle.</li> <li>10) Remove NUT (3 pcs. fixing the compressor to the bottom plate.</li> </ol>	 <p style="text-align: center;">Compressor</p>
⑧	Electronic expansion valve coil	<ol style="list-style-type: none"> <li><b>1. Detachment</b> <ol style="list-style-type: none"> <li>1) Perform step 1 in ①, all the steps in ② and 1 in ⑤.</li> <li>2) Turn the coil by 180 degrees then remove by pull it upward.</li> </ol> </li> <li><b>2. Attachment</b> <ol style="list-style-type: none"> <li>1) Insert the coil at position which perpendicular with pipe of PMV then turn the coil by 180 degrees.</li> </ol> <div style="border: 1px solid black; padding: 5px; margin: 10px 0;"> <p style="text-align: center;"><b>Make sure that lead wire of coil is opposite with pipe of PMV</b></p> </div> </li> </ol>	 <p style="text-align: center;">Rotate 180°C</p> <p style="text-align: center;">BODY-PMV COIL-PMV</p>
⑨	Fan Guard	<ol style="list-style-type: none"> <li><b>1. Detachment</b> <ol style="list-style-type: none"> <li>1) Perform work of item 1 of ②.</li> <li>2) Remove the front cabinet, and put it down so that fan guard side directs downward.</li> </ol> <div style="border: 1px solid black; padding: 5px; margin: 10px 0;"> <p style="text-align: center;"><b>Perform work on a corrugated cardboard, cloth, etc. to prevent flaw to the product.</b></p> </div> <ol style="list-style-type: none"> <li>3) Remove the hooking claws by pushing minus screwdriver according to the arrow mark in the right figure, and remove the fan guard.</li> </ol> </li> <li><b>2. Attachment</b> <ol style="list-style-type: none"> <li>1) Insert claws of the fan guard in the holes of the front cabinet. Push the hooking claws (9 positions) by hands and fix the claws</li> </ol> <div style="border: 1px solid black; padding: 5px; margin: 10px 0;"> <p style="text-align: center;"><b>All the attaching works have completed. Check that all the hooking claws are fixed to the specified positions.</b></p> </div> </li> </ol>	 <p style="text-align: center;">Minus screwdriver Hooking claw</p>

No.	Part name	Procedures	Remarks
⑩	TE sensor (outdoor heat exchanging temperature sensor)	<ul style="list-style-type: none"> <li>• <b>Attachment</b> Install the sensor onto the straight pipe part of the condenser output pipe.</li> </ul>	
⑪	TS sensor (Suction pipe temperature sensor)	<ul style="list-style-type: none"> <li>• <b>Attachment</b> Install the sensor onto the straight pipe part of the suction pipe. Be careful for the lead direction of the sensor.</li> </ul>	
⑫	TD sensor (Discharge pipe temperature sensor)	<ul style="list-style-type: none"> <li>• <b>Attachment</b> With its leads pointed upward, install the sensor onto the vertical straight pipe part of the discharge pipe.</li> </ul>	
⑬	TO sensor (Outside air temperature sensor)	<ul style="list-style-type: none"> <li>• <b>Attachment</b> Insert the outdoor air temperature sensor into the holder, and install the holder onto the heat exchanger.</li> </ul>	

**CAUTION**

During the installation work (and on its completion), take care not to damage the coverings of the sensor leads on the edges of the metal plates or other parts. It is dangerous for these coverings to be damaged since damage may cause electric shocks and/or a fire.

**CAUTION**

After replacing the parts, check whether the positions where the sensors were installed are the proper positions as instructed. The product will not be controlled properly and trouble will result if the sensors have not been installed in their proper positions.

## 12-4. Outdoor unit (RAS-18J2AVSG-TR)

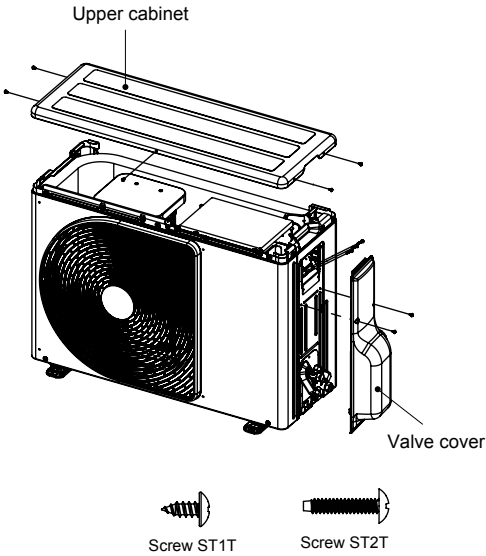
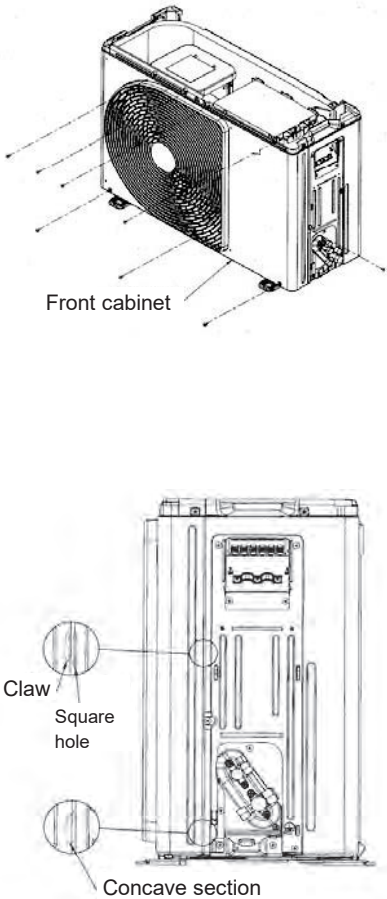
No.	Part name	Procedures	Remarks
①	Common procedure	<p><b>1. Detachment</b></p> <div style="border: 1px solid black; padding: 5px; margin: 10px 0;"> <p style="text-align: center;"><b>NOTE</b></p> <p><b>Wear gloves for this job. Otherwise, you may injure your hands on the parts, etc.</b></p> </div> <ol style="list-style-type: none"> <li>1) Stop operation of the air conditioner, and turn off the main switch of the breaker for air conditioner.</li> <li>2) Remove the valve cover. (ST2TØ4 × 10L 2 pcs.) <ul style="list-style-type: none"> <li>• After removing screw, remove the valve cover pulling it downward.</li> </ul> </li> <li>3) Remove cord clamp (ST2TØ4 × 14L 3 pcs.), and then remove connecting cable.</li> <li>4) Remove the upper cabinet. (ST2TØ4 × 10L 5 pcs.) <ul style="list-style-type: none"> <li>• After removing screws, remove the upper cabinet pulling it upward.</li> </ul> </li> </ol>	 <p>Upper cabinet</p> <p>Valve cover</p> <p>Screw ST1T      Screw ST2T</p>
②	Front cabinet	<p><b>1. Detachment</b></p> <ol style="list-style-type: none"> <li>1) Perform step 1 in ①.</li> <li>2) Remove the fixing screws (ST2TØ4 × 10L 2 pcs.) used to secure the front cabinet and inverter cover, the screws (ST2TØ4 × 10L 4 pcs.) used to secure the front cabinet at the bottom, and the fixing screws (ST2TØ4 × 10L 2 pcs.) used to secure the motor base. <ul style="list-style-type: none"> <li>• The front cabinet is fitted into the side cabinet (left) at the front left side so pull up the top of the front cabinet to remove it.</li> </ul> </li> </ol> <p><b>2. Attachment</b></p> <ol style="list-style-type: none"> <li>1) Insert the claw on the front left side into the side cabinet (left).</li> <li>2) Hook the bottom part of the front right side onto the concave section of the bottom plate. Insert the claw of the side cabinet (right) into the square hole in the front cabinet.</li> <li>3) Return the screws that were removed above to their original positions and attach them.</li> </ol>	 <p>Front cabinet</p> <p>Claw</p> <p>Square hole</p> <p>Concave section</p>

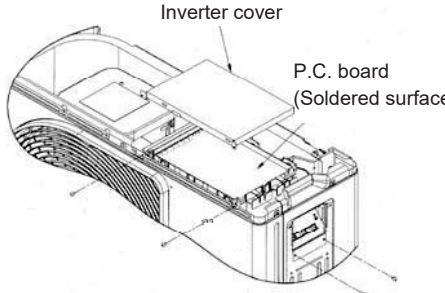
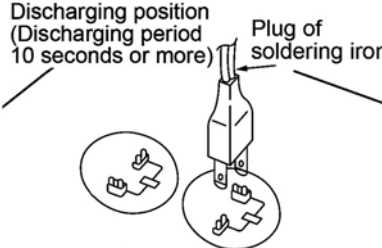
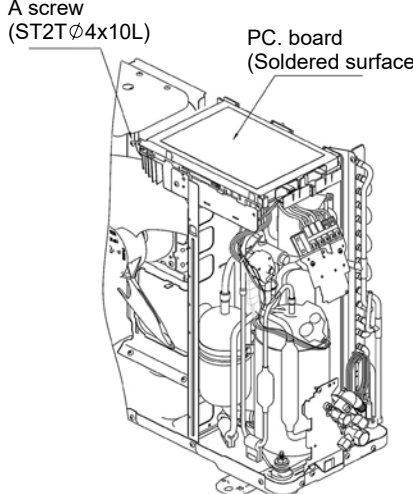
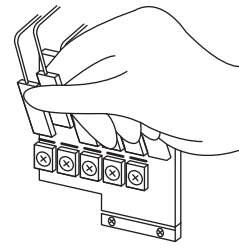

No.	Part name	Procedures	Remarks
③	Inverter assembly	<p>1) Perform work of item 1 in ①.</p> <p>2) Remove screw (ST2TØ4 × 10L 2 pcs.) of the upper part of the front cabinet.</p> <ul style="list-style-type: none"> <li>• If removing the inverter cover in this condition, P.C. board can be checked.</li> <li>• If there is no space above the unit, perform work of 1 in ②.</li> </ul> <div style="border: 1px solid black; padding: 5px; margin: 10px 0;"> <p><b>Be careful to check the inverter because high-voltage circuit is incorporated in it.</b></p> </div> <p>3) Perform discharging by connecting ⊕, ⊖ polarity by discharging resistance (approx. 100Ω40W) or plug of soldering iron ⊕ to ⊖, terminals a of the C09 ,C10 (printed “CAUTION HIGH VOLTAGE” is attached.) electrolytic capacitor (760μF) on P.C. board.</p> <div style="border: 1px solid black; padding: 5px; margin: 10px 0;"> <p><b>Be careful to discharge the capacitor because the electrolytic capacitor cannot naturally discharge and voltage remains according to trouble type in some cases.</b></p> </div> <div style="border: 1px solid black; padding: 5px; margin: 10px 0; text-align: center;"> <p><b>NOTE</b></p> <p><b>This capacitor is one with mass capacity. Therefore, it is dangerous that a large spark generates if short-circuiting between ⊕, ⊖</b></p> </div> <p>4) Remove screw (ST2TØ4 x 10L 4pcs.) fixing the terminal part of inverter box to the main body.</p> <p>5) Remove the front cabinet by performing step 1 in ②, and remove the fixing screws (ST2TØ4 x 10L) for securing the main body and inverter box.</p> <p>6) Remove various lead wires from the holder at upper part of the inverter box.</p> <p>7) Pull the inverter box upward.</p> <p>8) Disconnect connectors of various lead wires.</p> <div style="border: 1px solid black; padding: 5px; margin: 10px 0; text-align: center;"> <p><b>Requirement</b></p> <p><b>As each connector has a lock mechanism, avoid to remove the connector by holding the lead wire, but by holding the connector.</b></p> </div>	 <p>Inverter cover P.C. board (Soldered surface)</p>  <p>Discharging position (Discharging period 10 seconds or more) Plug of soldering iron</p>  <p>A screw (ST2TØ4x10L) P.C. board (Soldered surface)</p> <p>The connector is one with lock, so remove it while pushing the part indicated by an arrow.</p>  <p>Be sure to remove the connector by holding the connector, not by pulling the lead wire.</p>

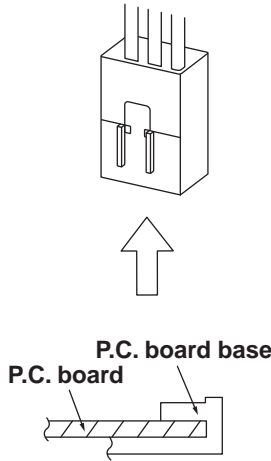
No.	Part name	Procedures	Remarks
④	Control board assembly	<p>1. Disconnect the leads and connectors connected to the other parts from the control board assembly.</p> <p>1) Leads</p> <ul style="list-style-type: none"> <li>• 3 leads (black, white, orange) connected to terminal block.</li> <li>• Lead connected to compressor : Disconnect the connector (3P).</li> <li>• Lead connected to reactor : Disconnect the connector (2P).</li> </ul> <p>2) Connectors</p> <p>CN300 : Outdoor fan motor (3P: white)*  (* : See <b>Note</b>)</p> <p>CN600 : TE sensor (2P: white)*  CN601 : TD sensor (3P: white)*  CN602 : TO sensor (2P: white)  CN603 : TS sensor (3P: white)*  CN700 : PMV (6P: white)  CN703 : 4-way valve (2P: yellow)*</p> <div style="border: 1px solid black; padding: 5px; margin: 10px 0;"> <p style="text-align: center;"><b>NOTE</b></p> <p><b>These connectors have a disconnect prevention mechanism: as such, the lock on their housing must be released before they are disconnected.</b></p> </div> <p>2. Remove the control board assembly from the P.C. board base. (Remove the heat sink a control board assembly while keeping them screwed together.)</p> <div style="border: 1px solid black; padding: 5px; margin: 10px 0;"> <p style="text-align: center;"><b>NOTE</b></p> <p><b>Disengage the four claws of the P.C. board base, hold the heat sink, and lift to remove it.</b></p> </div> <p>3. Remove the two fixing screws used to secure the heat sink and control board assembly.</p> <p>4. Mount the new control board assembly.</p> <div style="border: 1px solid black; padding: 5px; margin: 10px 0;"> <p style="text-align: center;"><b>NOTE</b></p> <p><b>When mounting the new control board assembly, ensure that the P.C. board is inserted properly into the P.C. board support groove.</b></p> </div>	 <p>CN300, CN600, CN601, CN602, CN603, CN700 and CN703 are connectors with locking mechanisms: as such, to disconnect them, they must be pressed in the direction of the arrow while pulling them out.</p>  <p style="text-align: center;">P.C. board base P.C. board</p>

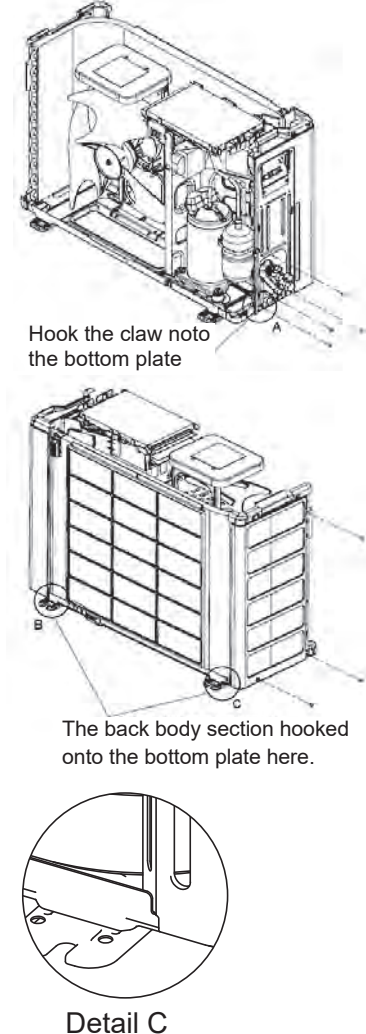
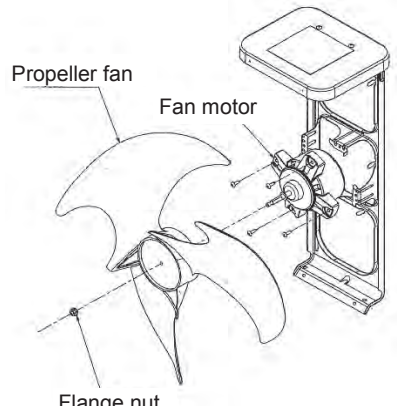
No.	Part name	Procedures	Remarks
⑤	Side cabinet	<p><b>1. Side cabinet (right)</b></p> <ol style="list-style-type: none"> <li>1) Perform step 1 in ② and all the steps in ③.</li> <li>2) Remove the fixing screw (ST2TØ4 × 10L 4 pcs.) used for securing the side cabinet to the bottom plate and valve fixing panel</li> </ol> <p><b>2. Side cabinet (left)</b></p> <ol style="list-style-type: none"> <li>1) Perform step 1 in ②.</li> <li>2) Remove the fixing screw (ST2TØ4 × 10L 1 pc.) used to secure the side cabinet (left) onto the heat exchanger.</li> <li>3) Remove the fixing screw (ST2TØ4 × 10L 2 pcs.) used for securing the side cabinet to the bottom plate and heat exchanger.</li> </ol>	
⑥	Fan motor	<ol style="list-style-type: none"> <li>1) Perform work of item 1 of ① and ②.</li> <li>2) Remove the flange nut fixing the fan motor and the propeller. <ul style="list-style-type: none"> <li>• Flange nut is loosened by turning clockwise. (To tighten the flange nut, turning counterclockwise.)</li> </ul> </li> <li>3) Remove the propeller fan.</li> <li>4) Disconnect the connector for fan motor from the inverter.</li> <li>5) Remove the fixing screws (4 pcs.) holding by hands so that the fan motor does not fall. <ul style="list-style-type: none"> <li>* Precautions when assembling the fan motor Tighten the flange nut using a tightening torque of 4.9 N•m.</li> </ul> </li> </ol>	

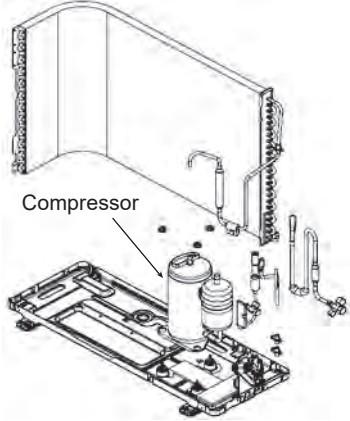
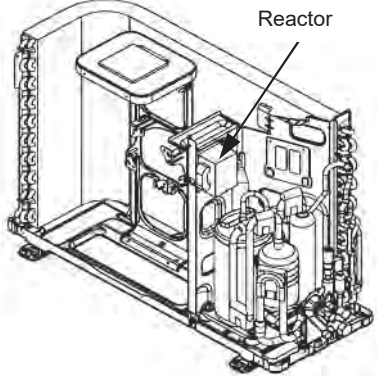
No.	Part name	Procedures	Remarks
⑦	Compressor	<ol style="list-style-type: none"> <li>1) Perform work of item 1 of ① and ②, ③, ④, ⑤.</li> <li>2) Extract refrigerant gas.</li> <li>3) Remove the partition board. (ST2TØ4 × 10L 3 pcs.)</li> <li>4) Remove the sound-insulation material.</li> <li>5) Remove terminal cover of the compressor, and disconnect lead wire of the compressor from the terminal.</li> <li>6) Remove pipe connected to the compressor with a burner.</li> <li>7) Remove the fixing screw of the bottom plate and heat exchanger. (ST2TØ4 × 10L 1 pc.)</li> <li>8) Remove the fixing screw of the bottom plate and valve fixing plate. (ST2TØ4 × 10L 1 pc.)</li> <li>9) Pull upward the refrigeration cycle.</li> <li>10) Remove NUT (3 pcs. fixing the compressor to the bottom plate.</li> </ol>	
⑧	Reactor	<ol style="list-style-type: none"> <li>1) Perform work of item 1 of ② and ③.</li> <li>2) Remove screws fixing the reactors (ST2TØ4 × 10L 2 pcs.)</li> </ol>	

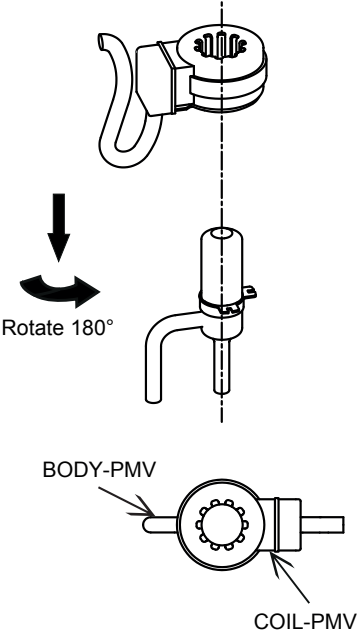
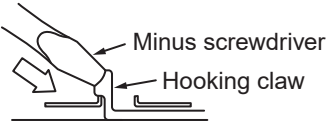
No.	Part name	Procedures	Remarks
⑨	Electronic expansion valve coil	<p><b>1. Detachment</b></p> <p>1) Perform step 1 in ①, all the steps in ② and 1 in ⑤.</p> <p>2) Turn the coil by 180 degrees then remove by pull it upward.</p> <p><b>2. Attachment</b></p> <p>1) Insert the coil at position which perpendicular with pipe of PMV then turn the coil by 180 degrees.</p> <div data-bbox="497 555 970 651" style="border: 1px solid black; padding: 5px; margin: 10px 0;"> <p><b>Make sure that lead wire of coil is opposite with pipe of PMV</b></p> </div>	 <p style="text-align: center;">Rotate 180°</p> <p style="text-align: center;">BODY-PMV</p> <p style="text-align: right;">COIL-PMV</p>
⑩	Fan Guard	<p><b>1. Detachment</b></p> <p>1) Perform work of item 1 of ② .</p> <p>2) Remove the front cabinet, and put it down so that fan guard side directs downward.</p> <div data-bbox="472 1193 944 1265" style="border: 1px solid black; padding: 5px; margin: 10px 0;"> <p><b>Perform work on a corrugated cardboard, cloth, etc. to prevent flaw to the product.</b></p> </div> <p>3) Remove the hooking claws by pushing minus screwdriver according to the arrow mark in the right figure, and remove the fan guard.</p> <p><b>2. Attachment</b></p> <p>1) Insert claws of the fan guard in the holes of the front cabinet.</p> <p>Push the hooking claws (9 positions) by hands and fix the claws</p> <div data-bbox="472 1559 944 1659" style="border: 1px solid black; padding: 5px; margin: 10px 0;"> <p><b>All the attaching works have completed. Check that all the hooking claws are fixed to the specified positions.</b></p> </div>	 <p style="text-align: right;">Minus screwdriver</p> <p style="text-align: right;">Hooking claw</p>

No.	Part name	Procedures	Remarks
⑪	TE sensor (outdoor heat exchanging temperature sensor)	<ul style="list-style-type: none"> <li>• <b>Attachment</b> Install the sensor onto the straight pipe part of the condenser output pipe.</li> </ul>	
⑫	TS sensor (Suction pipe temperature sensor)	<ul style="list-style-type: none"> <li>• <b>Attachment</b> Install the sensor onto the straight pipe part of the suction pipe. Be careful for the lead direction of the sensor.</li> </ul>	
⑬	TD sensor (Discharge pipe temperature sensor)	<ul style="list-style-type: none"> <li>• <b>Attachment</b> With its leads pointed upward, install the sensor onto the vertical straight pipe part of the discharge pipe.</li> </ul>	
⑭	TO sensor (Outside air temperature sensor)	<ul style="list-style-type: none"> <li>• <b>Attachment</b> Insert the outdoor air temperature sensor into the holder, and install the holder onto the heat exchanger.</li> </ul>	

**CAUTION**

During the installation work (and on its completion), take care not to damage the coverings of the sensor leads on the edges of the metal plates or other parts. It is dangerous for these coverings to be damaged since damage may cause electric shocks and/or a fire.

**CAUTION**

After replacing the parts, check whether the positions where the sensors were installed are the proper positions as instructed. The product will not be controlled properly and trouble will result if the sensors have not been installed in their proper positions.

## 13. EXPLODED VIEWS AND PARTS LIST

### 13-1. Indoor Unit

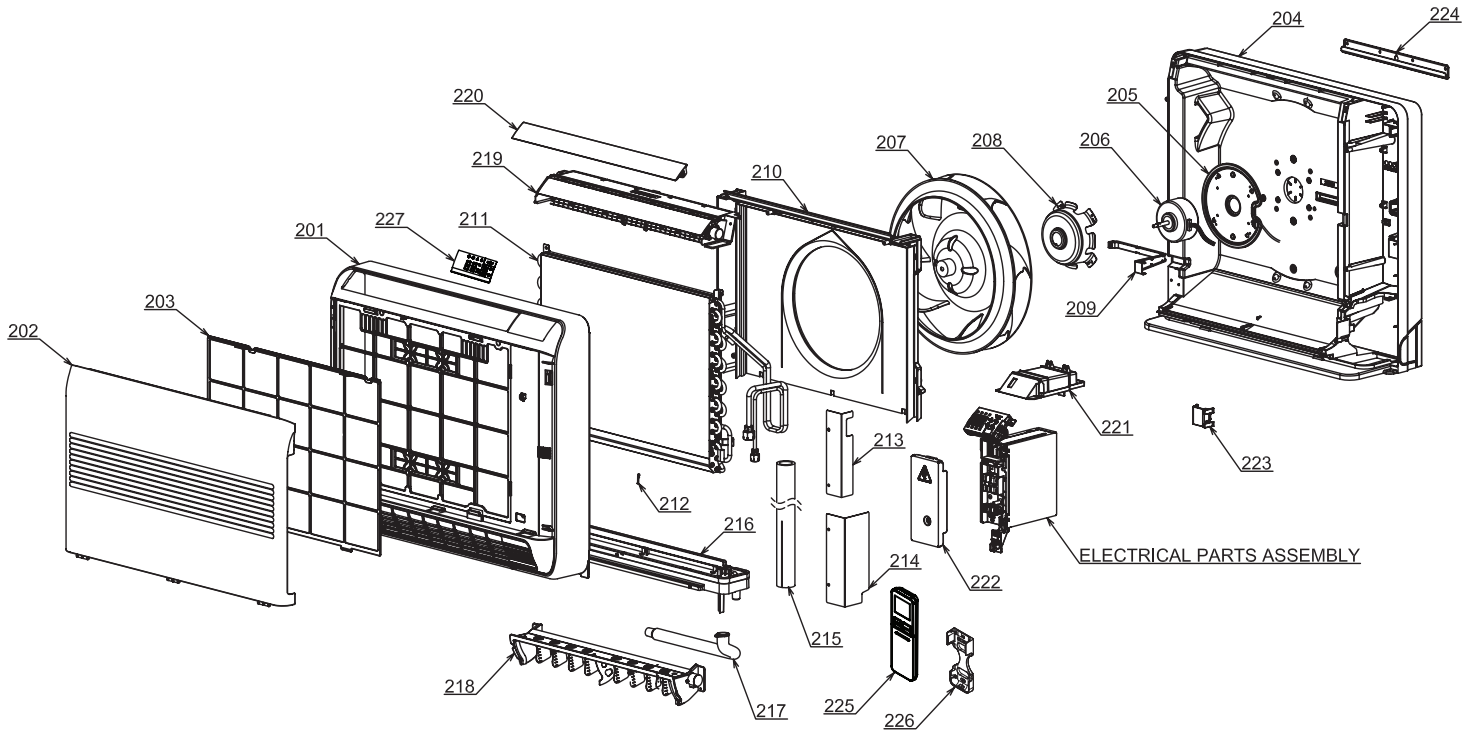

Location No.	Part No.	Description	Location No.	Part No.	Description
201	43T00553	FRONT PANEL ASSY	213	43T79314	DRAIN GUIDE (UP)
202	43T09460	INLET GRILLE ASSY	214	43T79315	DRAIN GUIDE (DOWN)
203	43T80325	AIR FILTER	215	43T49341	SHIELD PIPE
204	43T03379	BACK BODY ASSY	216	43T72310	DRAIN PAN ASSY
205	43T39340	MOTOR BASE ASSY	217	43T70313	HOSE, DRAIN
206	43T21424	FAN MOTOR ASSY	218	43T22317	DAMPER ASSY
207	43T20330	TURBO FAN ASSY	219	43T22316	UPPER LOUVER ASSY
208	43T60408	MOTOR HOLDER	220	43T22315	HORIZONTAL LOUVER
209	43T63331	LEAD COVER	221	43T63333	DISPLAY BASE
210	43T22314	BELL MOUTH ASSY	222	43T62339	TERMINAL COVER ASSY
211	43T44634	REFRIGERANT CYCLE ASSY (FOR RAS-18J2FVG-TR)	223	43T49340	PIPE HOLDER
211	43T44673	REFRIGERANT CYCLE ASSY (FOR RAS-10,13J2FVG-TR)	224	43T82316	PLATE MOUNTING
212	43T19333	HOLDER, SENSOR	225	43T66390	WIRELESS REMOCO
			226	43T83305	HOLDER, REMOTE CONTROL
			227	43T08425	SHEET-DISPLAY

## 13-2. Indoor Unit (E-Part)

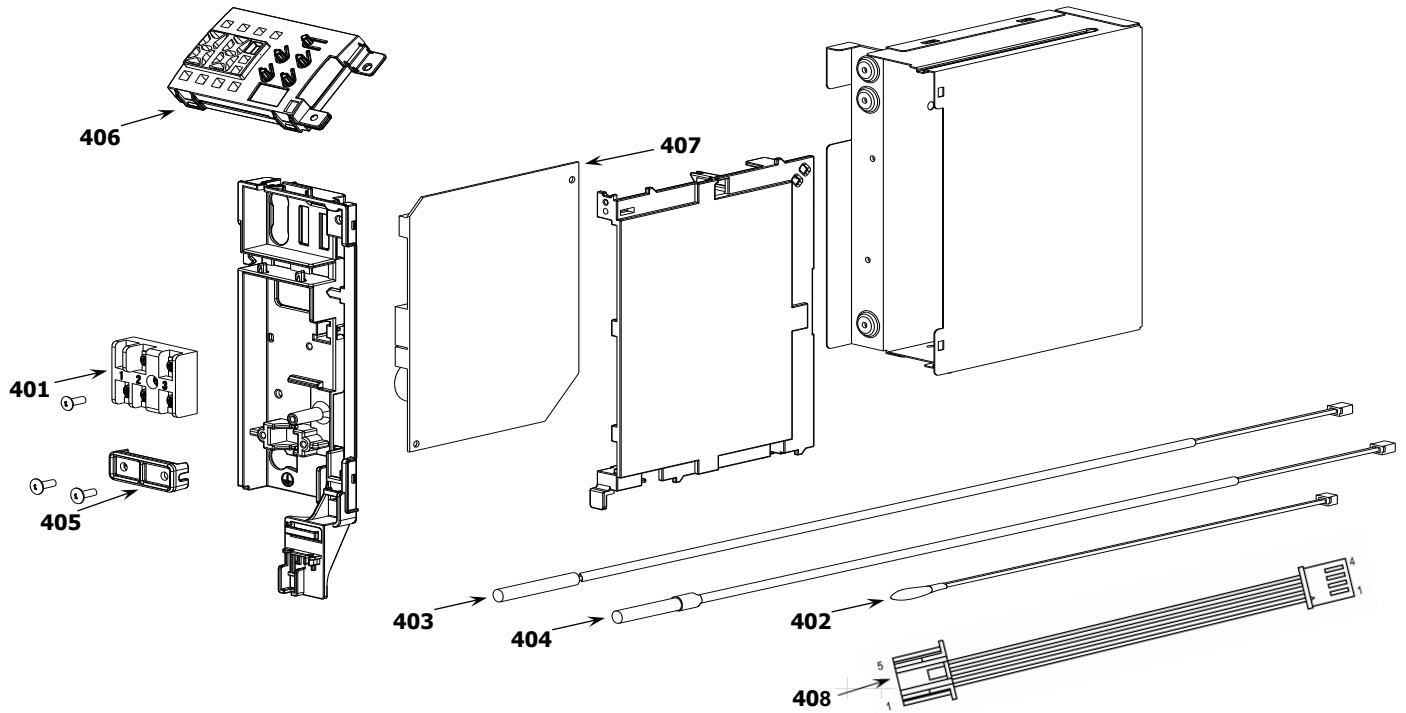

Location No.	Part No.	Description	Location No.	Part No.	Description
401	43T60406	TERMINAL 3P	407	43T6W712	PC BOARD (FOR RAS-13J2FVG-TR)
402	43T69320	TEMPERATURE SENSOR	407	43T6W743	PC BOARD (FOR RAS-18J2FVG-TR)
403	43T50395	TEMPERATURE SENSOR	408	43T60502	HOUSING-WiFi
404	43T50333	SENSOR:HEAT EXCHANGER			
405	43T62003	CORD CLAMP			
406	43T69865	PC BOARD ASSY,WRS-LED			
407	43T6W711	PC BOARD (FOR RAS-10J2FVG-TR)			



### 13-3. Outdoor Unit

RAS-10, 13J2AVSG-TR, TR1

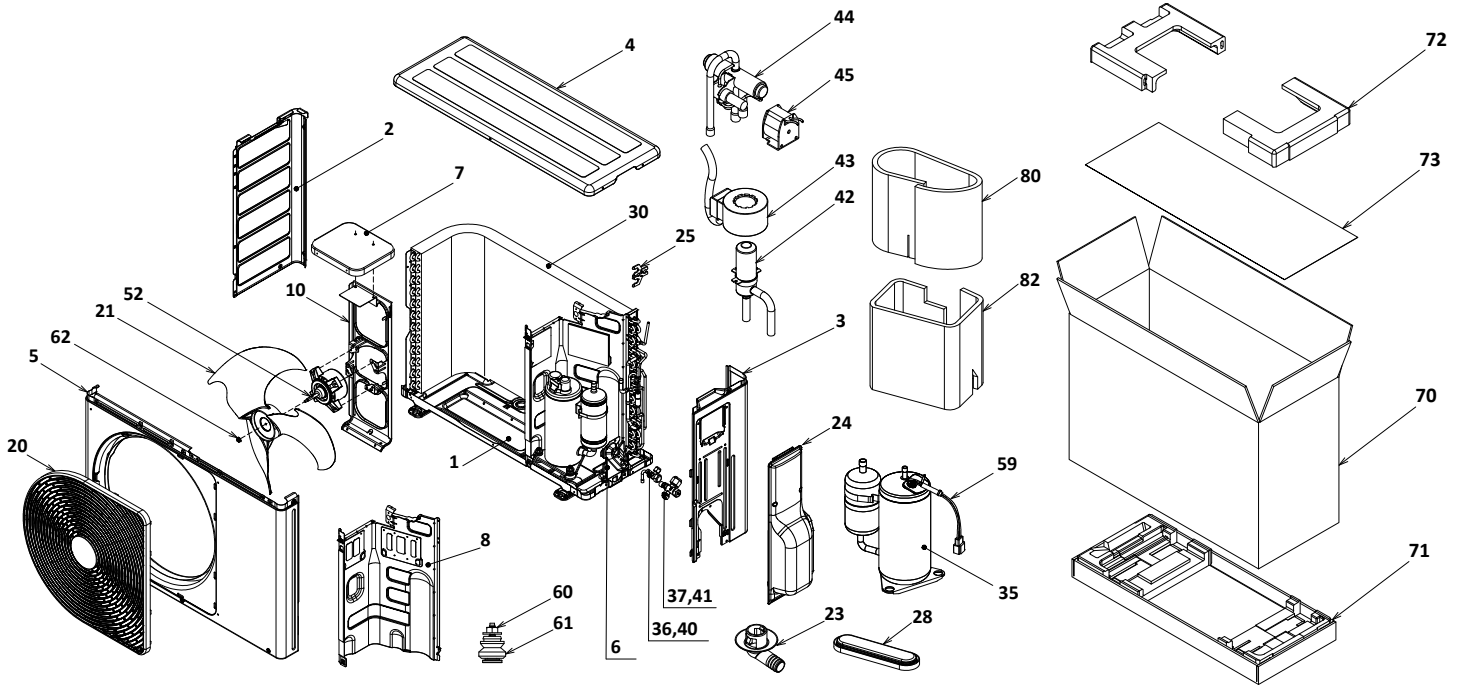

Location No.	Part No.	Description	Location No.	Part No.	Description
1	43T42327	BASE PLATE ASSEMBLY (FOR RAS-10,13J2AVSG-TR)	35	43T41533	COMPRESSOR (FOR RAS-10J2AVSG-TR,TR1)
1	43T42382	BASE PLATE ASSEMBLY (FOR RAS-10,13J2AVSG-TR1)	36	43T47403	BONNET, 6.35 DIA
2	43T00459	LEFT CABINET	37	43T47404	BONNET, 9.52 DIA
3	43T00690	RIGHT CABINET ASSEMBLY	40	43T46435	VALVE; PACKED 6.35 DIA
4	43T00735	UPPER CABINET ASSEMBLY	41	43T46436	VALVE; PACKED 9.52 DIA
5	43T00737	FRONT CABINET ASSEMBLY	42	43T46469	BODY PMV
6	43T00448	FIXING PLATE VALVE	43	43T63360	COIL PMV
7	43T39333	MOTOR BASE CONNECTION PLATE	44	43T46367	4 WAY VALVE (FOR RAS-10J2AVSG-TR,TR1)
8	43T04330	PARTITION ASSEMBLY (FOR RAS-10J2AVSG-TR,TR1)	44	43T46470	4 WAY VALVE (FOR RAS-13J2AVSG-TR,TR1)
8	43T04340	PARTITION ASSEMBLY (FOR RAS-13J2AVSG-TR,TR1)	45	43T63327	COIL-4WAY (FOR RAS-10J2AVSG-TR,TR1)
10	43T39393	MOTOR BASE	45	43T63361	4 WAY VALVE (FOR RAS-13J2AVSG-TR,TR1)
20	43T19364	FAN GUARD	52	43T21460	FAN MOTOR
21	43T20319	PROPELLER FAN	59	43T60505	LEAD ASSY, COMPRESSOR
23	43T79305	DRAIN NIPPLE (FOR RAS-10,13J2AVSG-TR)	60	43T97001	NUT
23	43T79325	DRAIN NIPPLE (FOR RAS-10,13J2AVSG-TR1)	61	43T49327	CUSHION,RUBBER
24	43T00762	PACKED-VALVE COVER ASSEMBLY	62	43T47001	NUT FLANGE
25	43T63376	HOLDER, SENSOR	70	43T91343	CARTON BOX
28	43089160	CAP, WATERPROOF	71	43T91342	FIBERBOARD UNDER ASSEMBLY
30	43T43545	CONDENSER ASSEMBLY (FOR RAS-13J2AVSG-TR,TR1)	72	43T91314	CUSHION-PKG-UPR
30	43T43603	CONDENSER ASSEMBLY (FOR RAS-10J2AVSG-TR,TR1)	73	43T91301	PE SHEET
35	43T41521	COMPRESSOR (FOR RAS-13J2AVSG-TR,TR1)	80	43T04357	SOUND INSULATION(IS)
			82	43T04429	INSULATION SOUND OUTSIDE

# 13-4. Outdoor Unit

RAS-18J2AVSG-TR

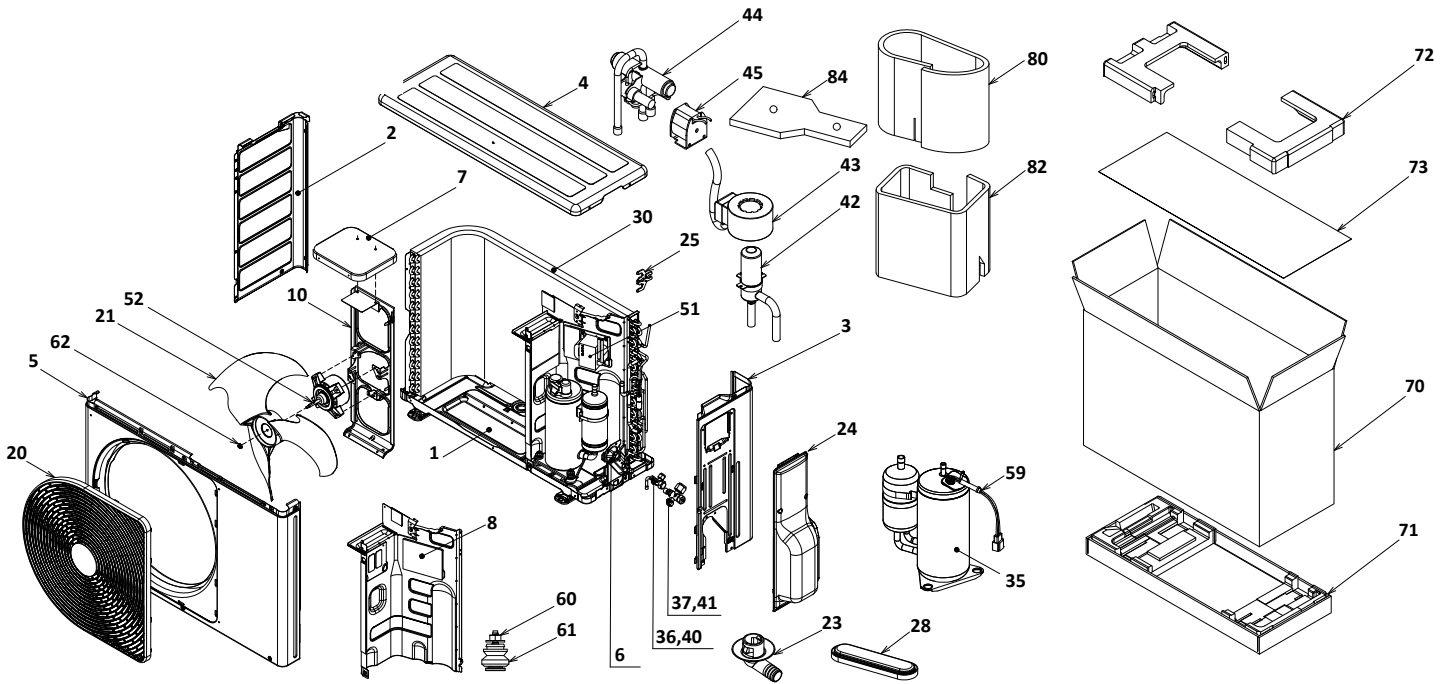

Location No.	Part No.	Description	Location No.	Part No.	Description
1	43T42327	BASE PLATE ASSEMBLY	40	43T46435	VALVE; PACKED 6.35 DIA
2	43T00459	LEFT CABINET	41	43T46461	VALVE; PACKED 12.7 DIA
3	43T00690	RIGHT CABINET ASSEMBLY	42	43T46469	BODY PMV
4	43T00735	UPPER CABINET ASSEMBLY	43	43T63360	COIL PMV
5	43T00688	FRONT CABINET ASSEMBLY	44	43T46367	4 WAY VALVE
6	43T00448	FIXING PLATE VALVE	45	43T63327	COIL-4WAY
7	43T39333	MOTOR BASE CONNECTION PLATE	51	43T58309	REACTOR
8	43T04362	GUIDE WIND PARTITION ASSEMBLY	52	43T21460	FAN MOTOR
10	43T39393	MOTOR BASE	59	43T60494	LEAD ASSY, COMPRESSOR
20	43T19364	FAN GUARD	60	43T97001	NUT
21	43T20319	PROPELLER FAN	61	43T49327	CUSHION,RUBBER
23	43T79305	DRAIN NIPPLE	62	43T47001	NUT FLANGE
24	43T00762	PACKED-VALVE COVER ASSEMBLY	70	43T91343	CARTON BOX
25	43T63376	HOLDER, SENSOR	71	43T91342	FIBERBOARD UNDER ASSEMBLY
28	43089160	CAP, WATERPROOF	72	43T91314	CUSHION-PKG-UPR
30	43T43562	CONDENSER ASSEMBLY	73	43T91301	PE SHEET
35	43T41522	COMPRESSOR	80	43T04357	SOUND INSULATION(IS)
36	43T47403	BONNET, 6.35 DIA	82	43T04429	INSULATION SOUND OUTSIDE
37	43T47405	BONNET, 12.7 DIA	84	43T04416	SOUND INSULATION(UP)

**13-5. Outdoor Unit (Part-E)**  
**RAS-10, 13J2AVSG-TR, TR1**

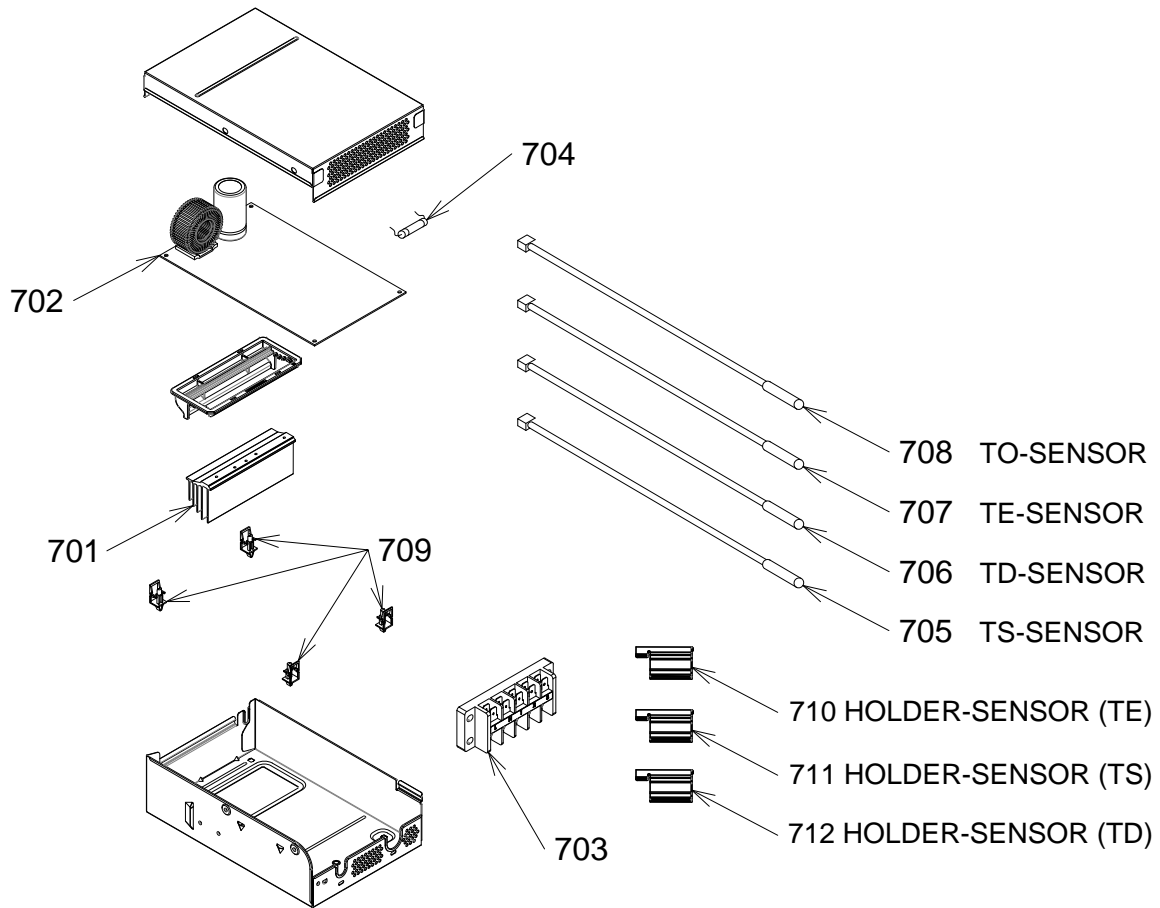

Location No.	Part No.	Description	Location No.	Part No.	Description
701	43T67311	HEATSINK	704	43T60459	FUSE
702	43T6W705	PC BOARD ASSY (FOR RAS-10J2AVSG-TR)	705	43T50353	TEMPERATURE SENSOR
702	43T6W706	PC BOARD ASSY (FOR RAS-13J2AVSG-TR)	706	43T50334	TEMPERATURE SENSOR
702	43T6W876	PC BOARD ASSY (FOR RAS-10J2AVSG-TR1)	707	43T50352	TEMPERATURE SENSOR
702	43T6W877	PC BOARD ASSY (FOR RAS-13J2AVSG-TR1)	708	43T50360	TC-SENSOR(TO)
703	43T60392	TERMINAL-5P	709	43T95304	SPACER-KGES
			710	43T63318	HOLDER SENSOR
			711	43T63316	HOLDER,SENSOR
			712	43T63317	HOLDER,SENSOR

### 13-6. Outdoor Unit (Part-E)

RAS-18J2AVSG-TR

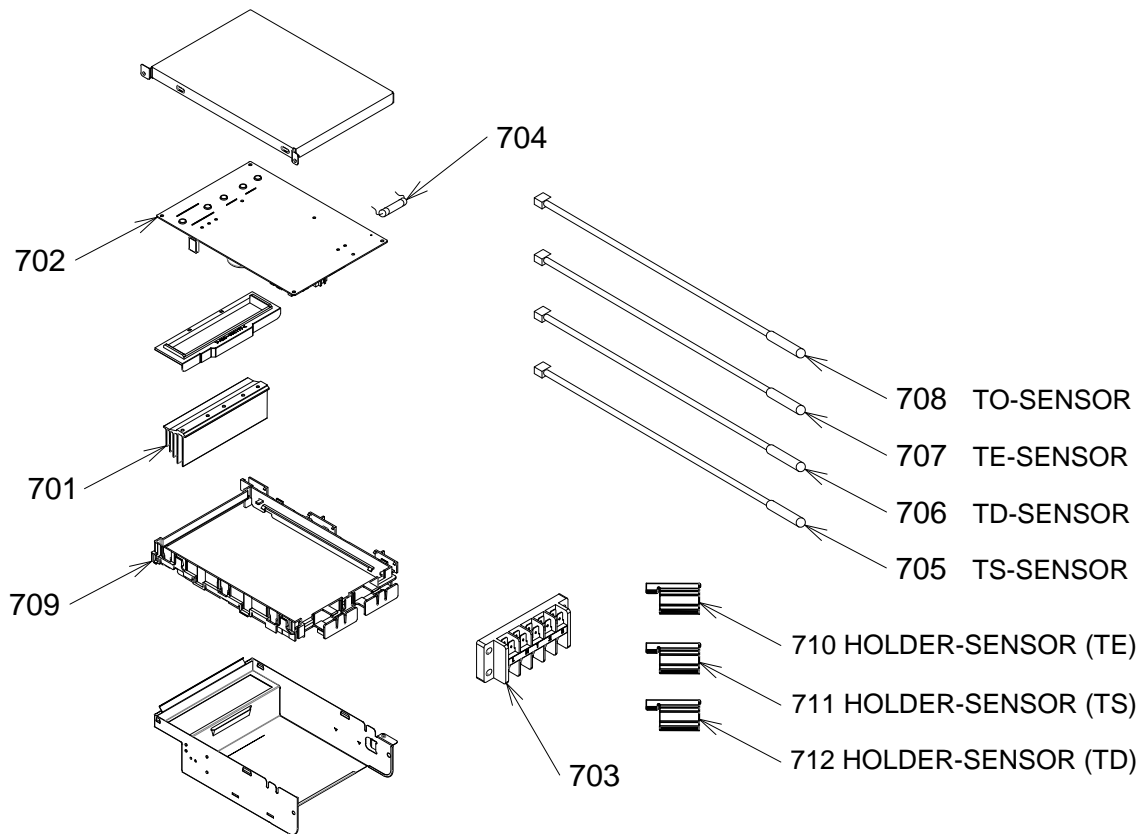

Location No.	Part No.	Description	Location No.	Part No.	Description
701	43T62351	HEATSINK	707	43T50352	TEMPERATURE SENSOR
702	43T6W708	PC BOARD ASSY	708	43T50360	TC-SENSOR(TO)
703	43T60392	TERMINAL-5P	709	43T62313	PC PLATE BASE
704	43T60326	FUSE	710	43T63318	HOLDER SENSOR
705	43T50353	TEMPERATURE SENSOR	711	43T63316	HOLDER,SENSOR
706	43T50334	TEMPERATURE SENSOR	712	43T63317	HOLDER,SENSOR

# **Toshiba Carrier (Thailand) Co., Ltd.**

**144/9 MOO 5, BANGKADI INDUSTRIAL PARK, TIVANON ROAD, TAMBOL BANGKADI,  
AMPHUR MUANG, PATHUMTHANI 12000, THAILAND.**